

Bootzeil

ShapeX – Instructions for sailing yachts

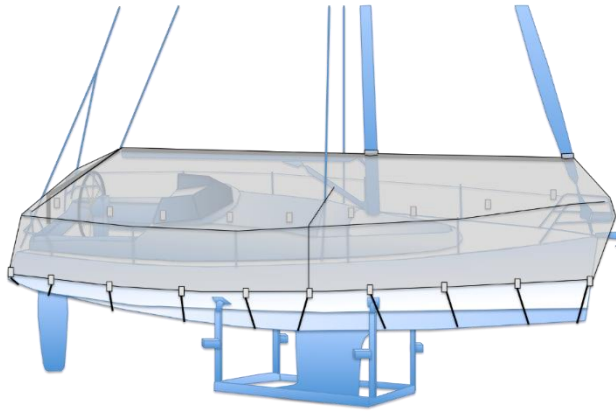

On the shore

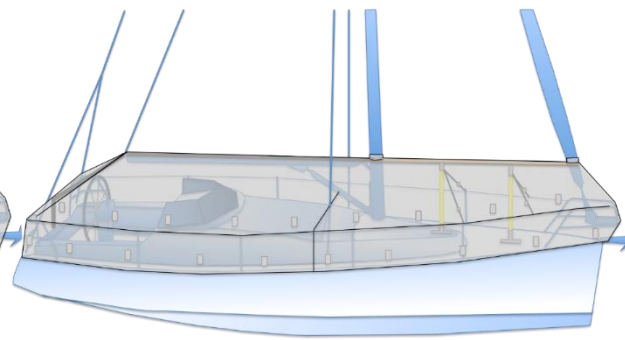

In the water

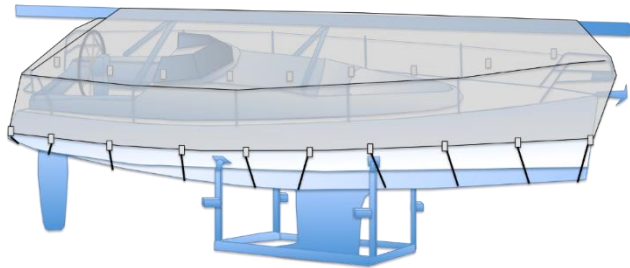

Lying mast

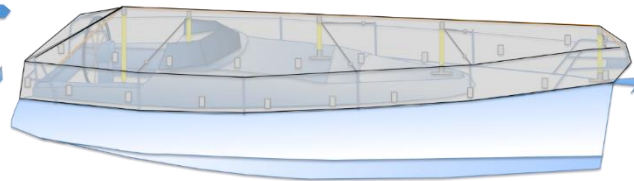

Hurricane frame

ShapeX: multiple possibilities

Our pride

Currently, Bootzeil is the most innovative producer of boat covers. With pride we present our "ShapeX" set to you, enabling you to create your own boat cover. Thanks to our practical components, special glue and high quality "Endurance+" material, you can easily determine the location of the components and tailor your boat cover in any way you want. The entire Bootzeil ShapeX team and its partners Griffon, Heytex and 3M Venture tape wish you success and a good time while making your own tailor-made boat cover.

Videos about installation:

Check out the online clips before installing your boat cover. Good preparation gives an easy job.

<http://www.bootzeil.nl/Alle-instructies-sp-6.html>

Installation service:

The installation can also be done by experienced installers.

Call 023 - 521 96 92 or send an e-mail to:

info@bootzeil.nl





Winter care service:

- Fixing once a year
- Interim check-up
- Taking off once a year
- Maintenance once a year
- Storage during summer

Disclaimer

- The color of the glue may change upon contact with UV light.
- When tape is taken off, it may leave residues behind.
- Glue should dry at least 3 minutes before tension is exerted on it.
- After 12 hours the glue is completely dry.
- To prevent mistakes, steps should be followed in the correct following order.
- Read the entire manual before installation. This will give you a clear picture of the process.
- If you don't understand a procedure, contact Bootzeil or check the videos on the website. The set contains exactly enough components for installing one boat cover. If you make a mistake and lose a component, you can order that component separately (for your convenience, try to prevent this).
- The boat cover can withstand snow. Nevertheless Bootzeil recommends to remove extreme amounts of snow.

List of symbols	6
Included in the set	7
Gluing instructions	8
Placing the frame	11
Positioning the boat cover	12
Leading the mast, topping line, baby stay and headsail/forestay through	13
Marking	16
Adjusting	20
Placing	30
Fixing the boat cover after the first installation	36
FAQ	37

	Indicates important actions which can prevent mistakes.
	Additional information.
	A hint which may help during the installation of the boat cover.
	This symbol indicates that the gluing instructions should be strictly adhered to. Gluing will be necessary.

Additional requirements

- A frame (Bootzeil recommends the 'Hurricane' frame)
- A day with nice weather (not too much rain, not too much wind)
- A lighter
- Masking tape
- A cheap cover of 4x4 meters, or a clean surface (not always necessary)
- The one-time installation can be done by one person, but is easier with 2 people.

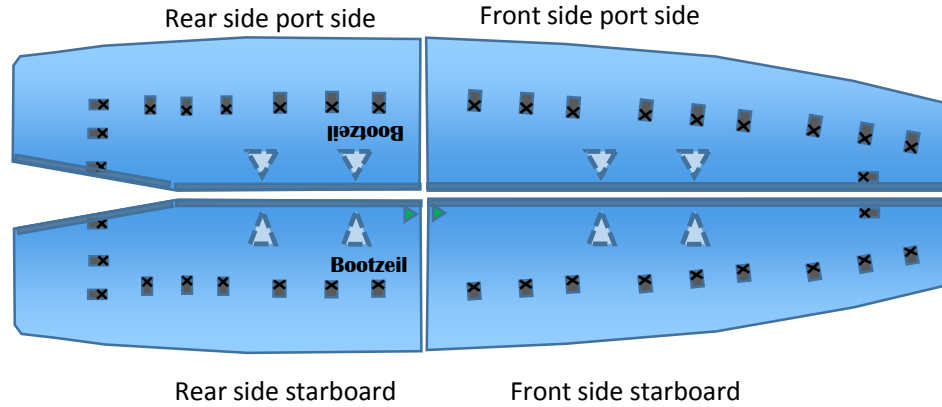

Preparation

- First read the entire manual
- Check the set

TIP Keep the remains of the ShapeX set and remaining boat cover, as they may be useful for repairs.

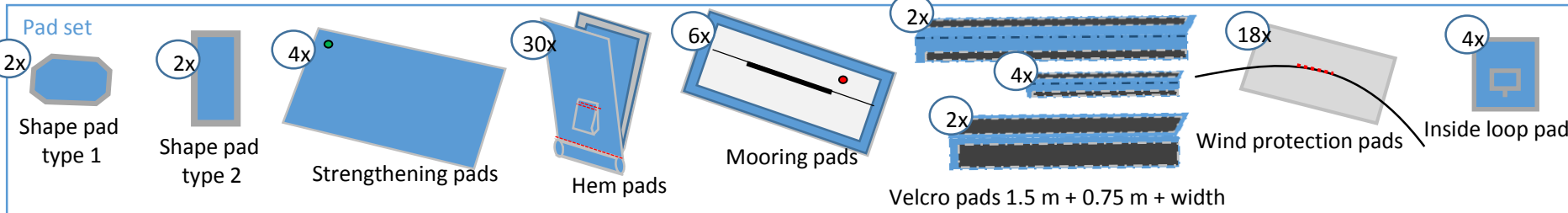

Gluing instructions



If you see this symbol, you should adhere to the gluing instructions.

Requirements



Griffon/Saba glue



BWF glue (white tube)



Screw



Brake cleaner



Towel

Preparation

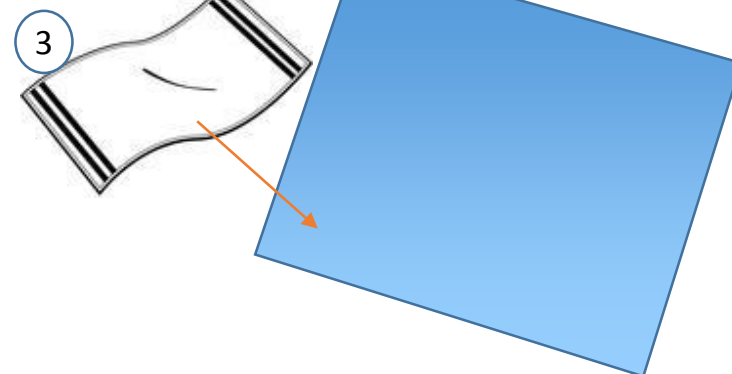
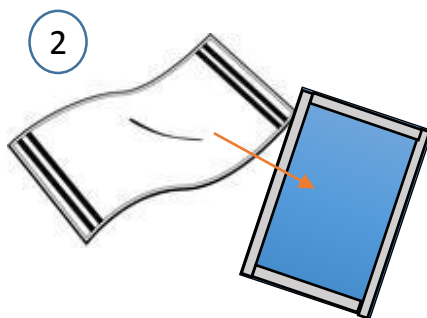
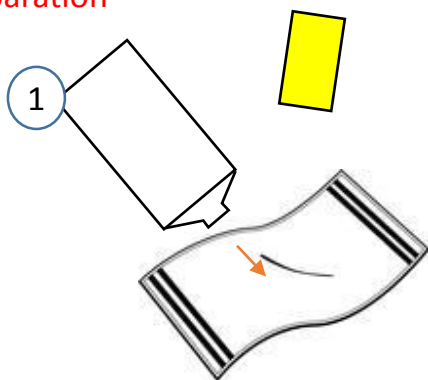



i The glue sticks better upon properly degreasing the surface.

Gluing instructions

Phase 1: Griffon glue (use when the temperature is at least 10°C)

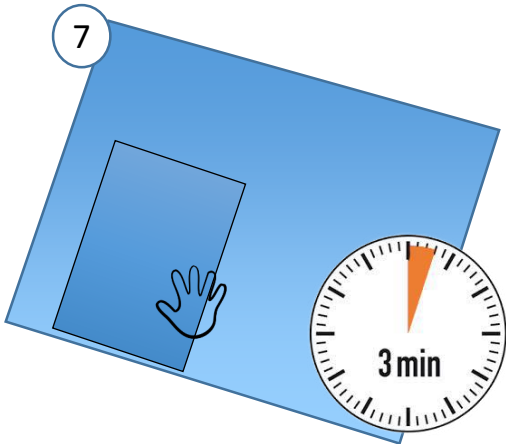
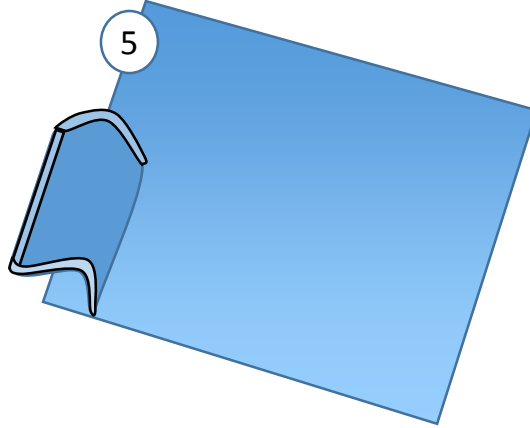
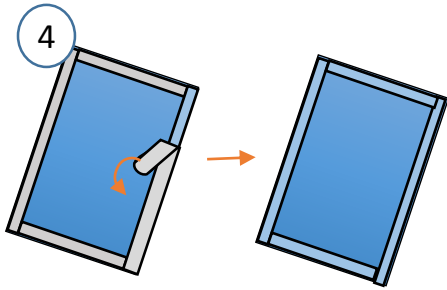
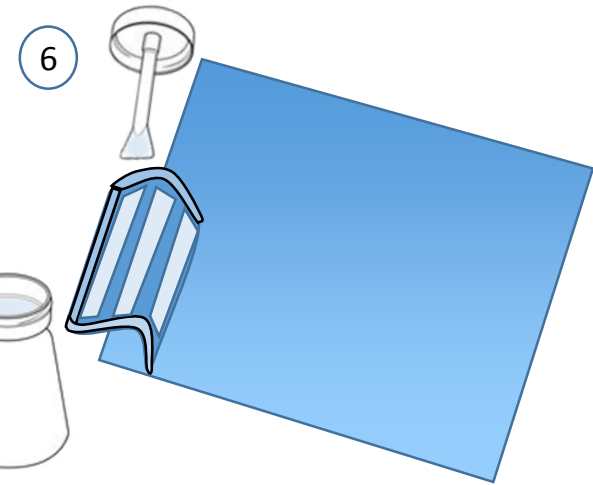
Saba glue (use when the temperature is at least 5°C)



 Exposure to UV light may cause the color of the glue to change. For that reason, ensure that the glue is only below the glued on component. In case the glue comes out from under the component, try to wipe it off with a towel as soon as possible.

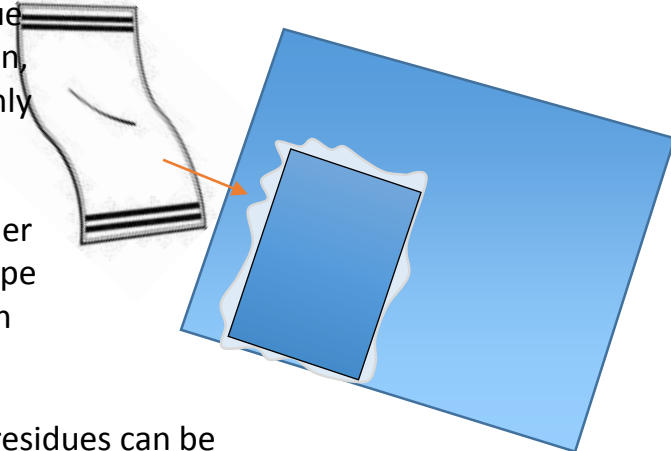

 However, glue residues can be removed with a glue "cleaner", to be ordered separately.

 To prevent glue residues, you can place masking tape around the location of the pad. Any excess glue will spill on the tape, instead of on the boat cover.



Gluing instructions

Phase 2: BWF glue (use when the temperature is at least 5°C)

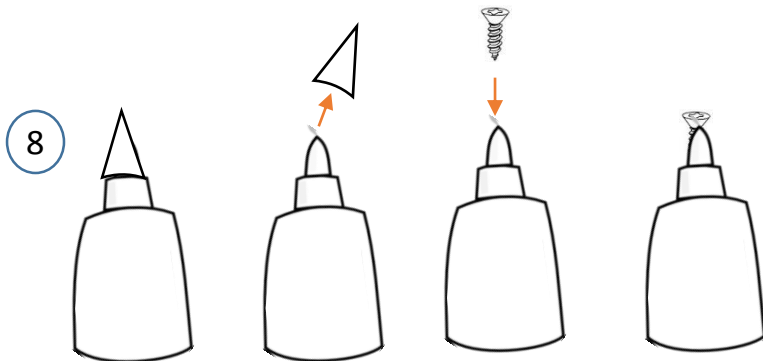

i By positioning the screw in the glue tube, it is easier to apply the right amount of glue.



The BWF glue should be applied horizontally. Take the boat cover from the boat to lay it flat and add glue to the glue seams.

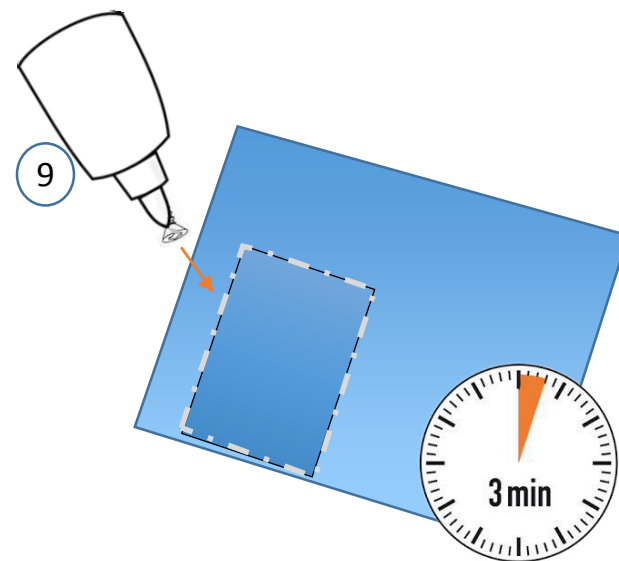

Be careful when applying glue. Excessive gluing will affect the appearance of the boat cover.



We advise you to try to glue a bit on the inside of the boat cover first, to get a feel for which quantity should be used.

Placing the frame

Lying mast

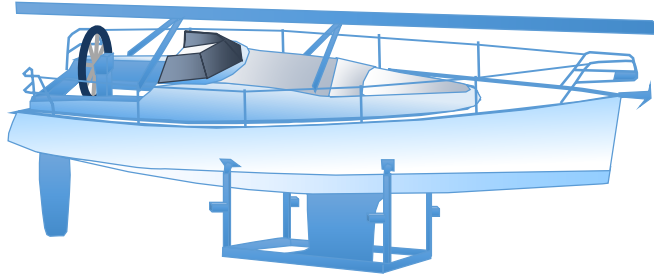

If you use a lying mast, you don't need a frame. Use the approximate height of the boom. Placing it too low will result in complications.

With boom

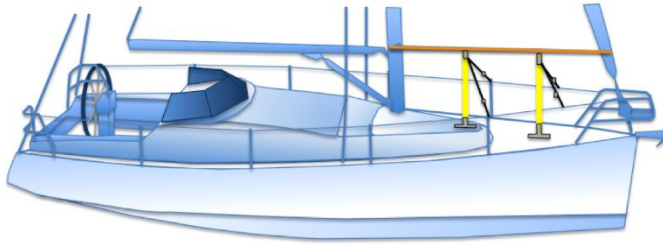

In case of using the Hurricane frame, make sure to read the manual before fixing the frame.

Without boom

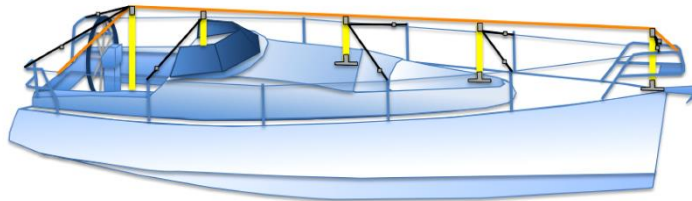

Positioning the boat cover

The approx. 10 cm wide Velcro strap is the center line.

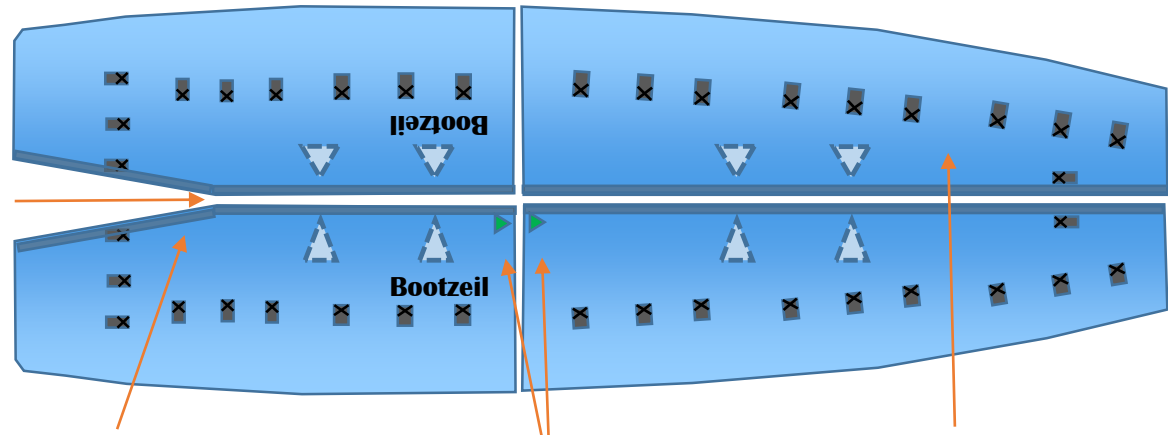

On the rear side, the boat cover has an integrated corner. It should be placed exactly at the end of the boom/topping lift.

The colored markings indicate starboard.

Using the wide Velcro strap, attach the port side segments to the starboard segments.

1

Lay the boat cover segments on the boat.

2

Position the boat cover on your boat.

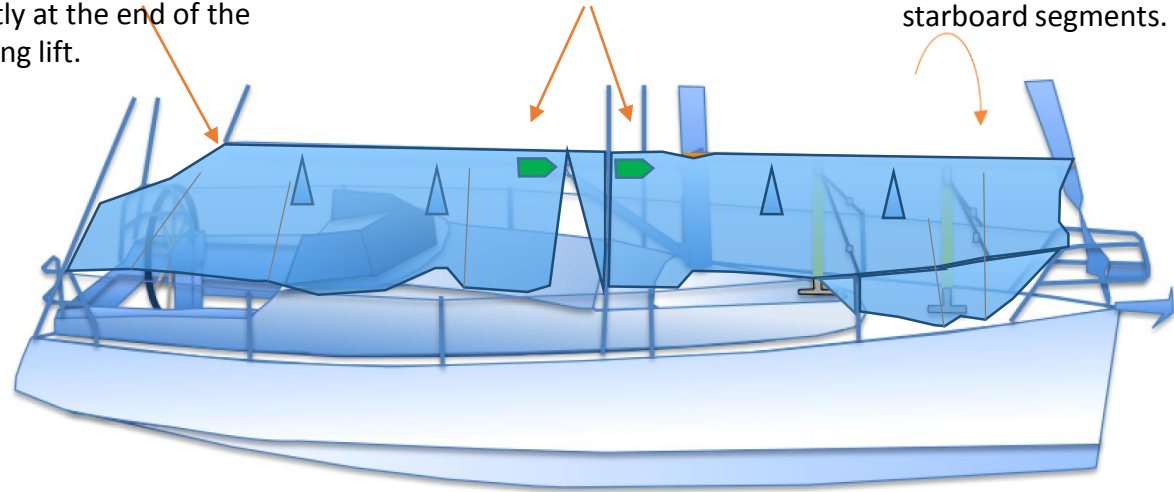

Leading the mast, topping line, baby stay and headsail/forestay through

 If you don't use the boat cover with a standing mast, you don't have to take the mast and stays into account.

Preparation:

- Check whether the rear corner of the boat cover is at the topping line and end of the boom. Make sure the Velcro strap is neatly arranged!
- There may be excess material on the front side. The rear side should approximately fit.
- Fold the Velcro straps around the stays and mast as neatly as possible. Create tension over the length of the boat cover.

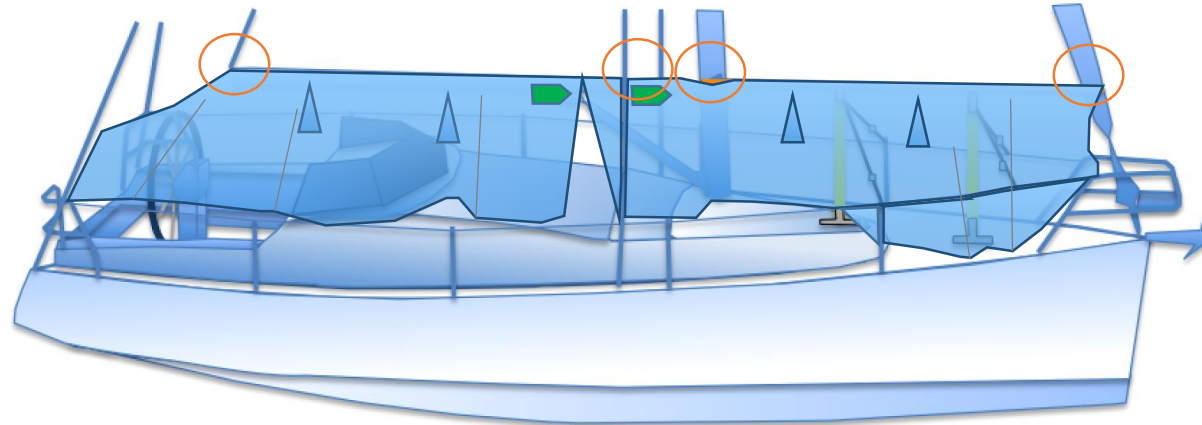

Leading the mast, topping line, baby stay and headsail/forestay through

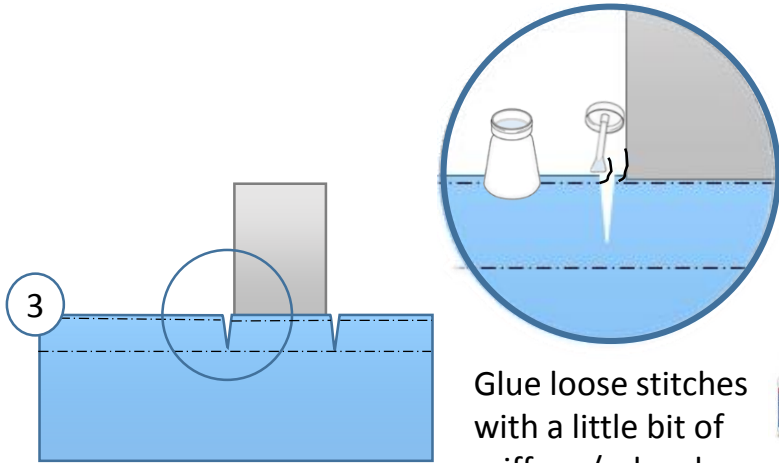
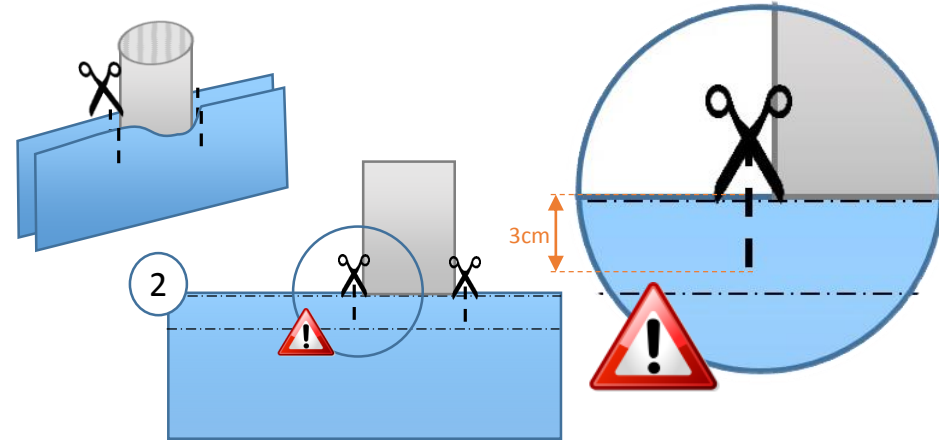
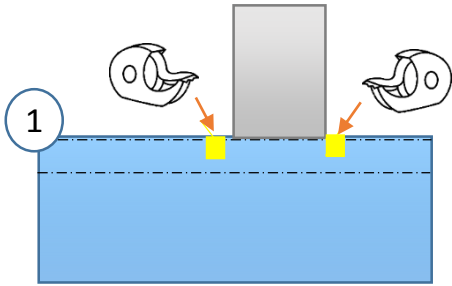

Glue loose stitches with a little bit of griffoen/saba glue (use sparsely).

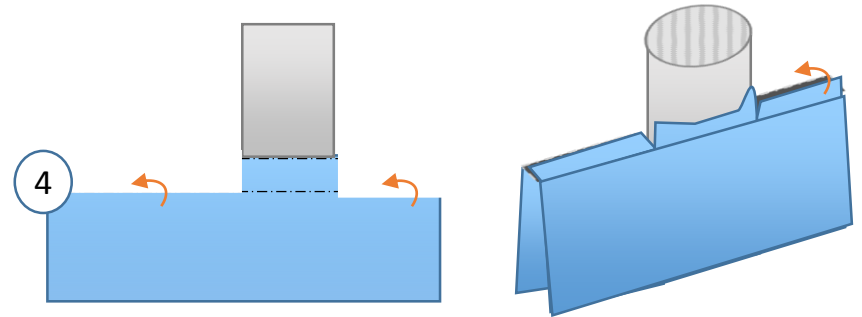

Repeat these steps for the holding line, mast, baby stay and headsail/forestay.



Leading the mast, topping line, baby stay and headsail/forestay through

Illustrative pictures



Marking: moorings/shrouds

Marking takes place on the boat.

Checklist marking	
Moorings/shrouds	
Corners rear side	
Length of boat cover/front side	

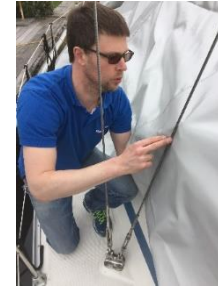
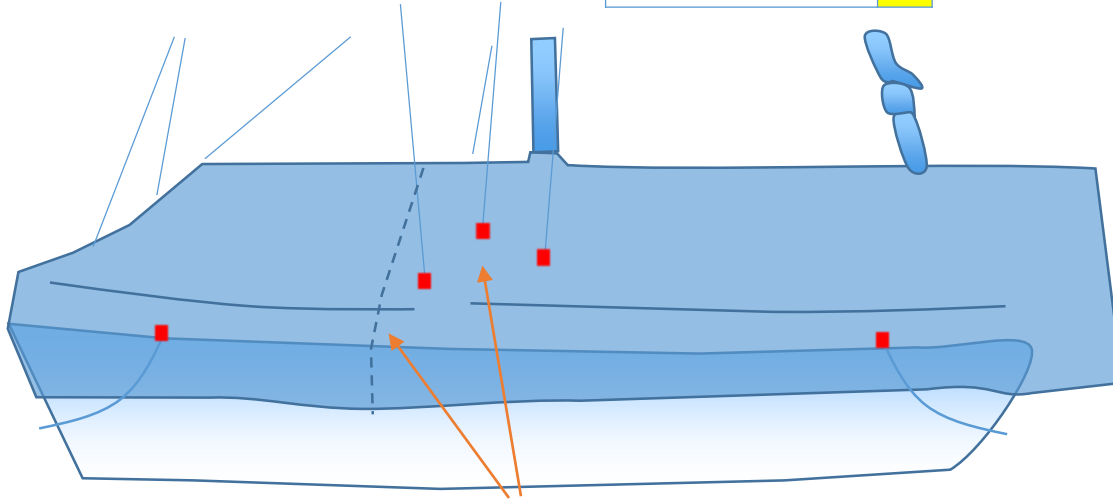

To prevent the shrouds from getting into the way, leave the zipper open while marking. (It is possible to already cut the boat cover at one of the shrouds, enabling the boat cover to fit over the rub rail. This simplifies the marking process.)

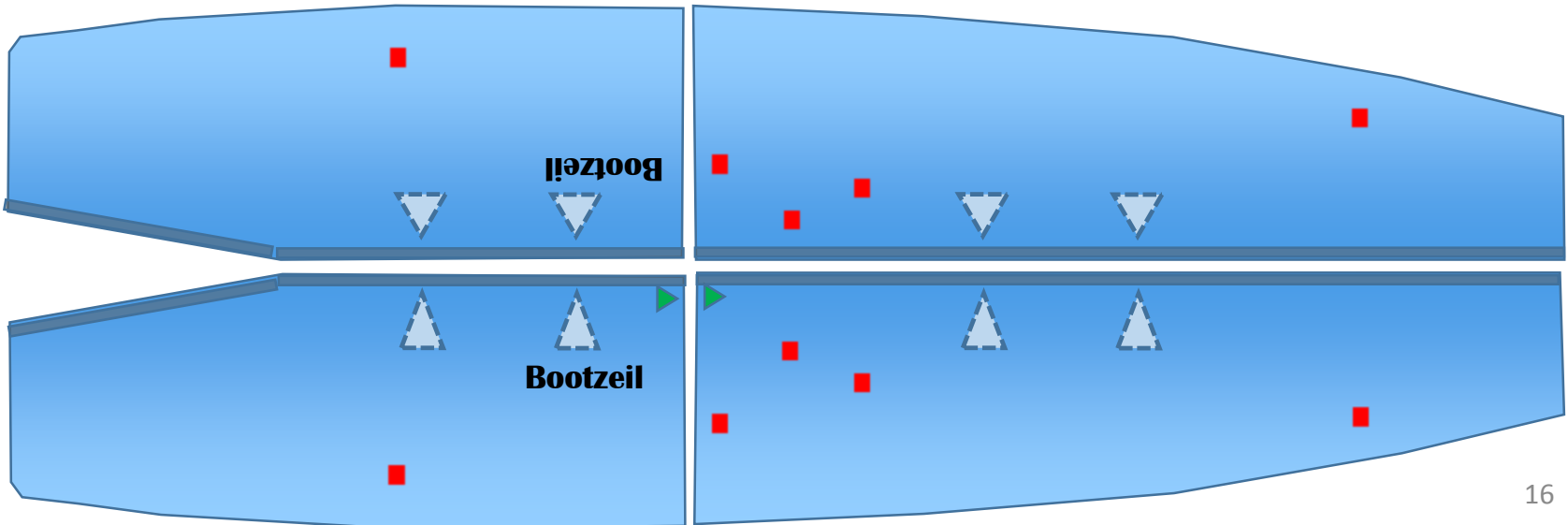

Marking: moorings/shrouds

Marking takes place on the boat.

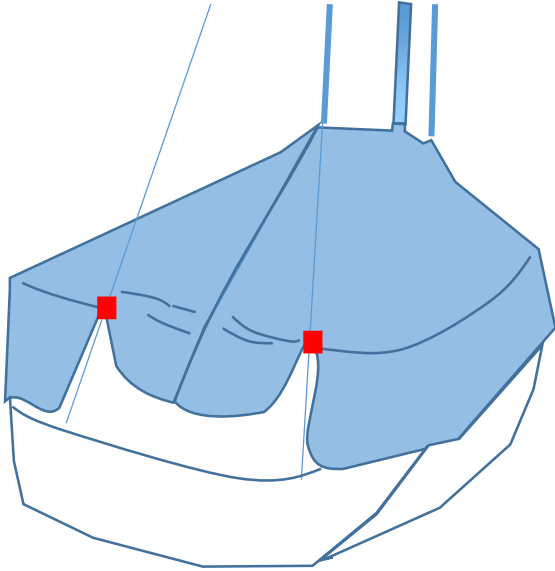

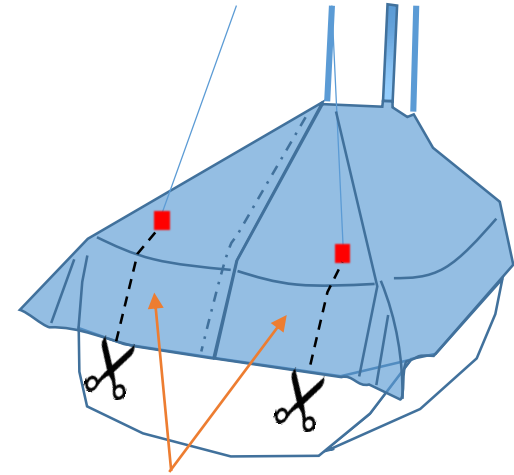

Checklist marking	
Moorings/shrouds	
Corners rear side	
Length of boat cover/front side	

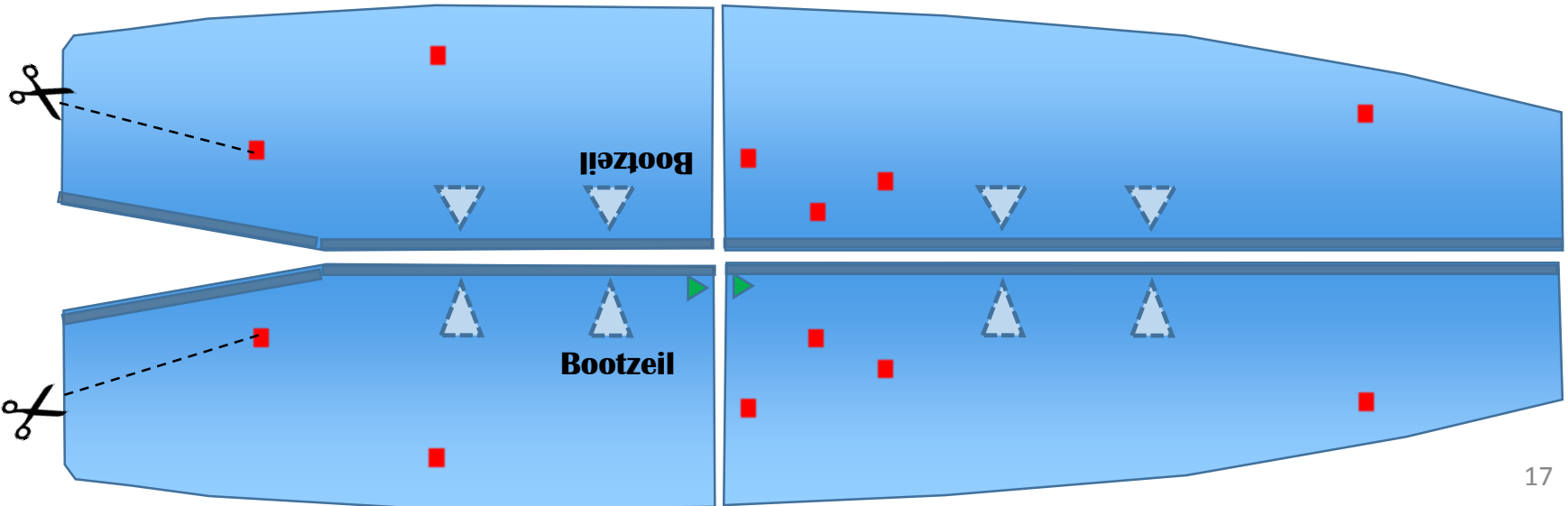

To enable the next step (corners rear side), the sail should already be cut at these locations. They will be finished during the adjustment phase.



Marking: corners rear side

Checklist marking	
Moorings/shrouds	
Corners rear side	
Length of boat cover/front side	



1

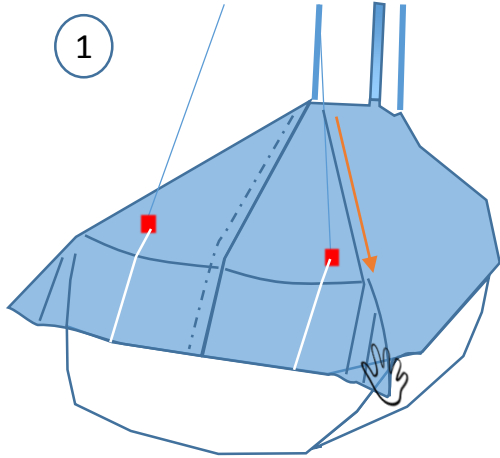

Pull the corners tightly in position.

2

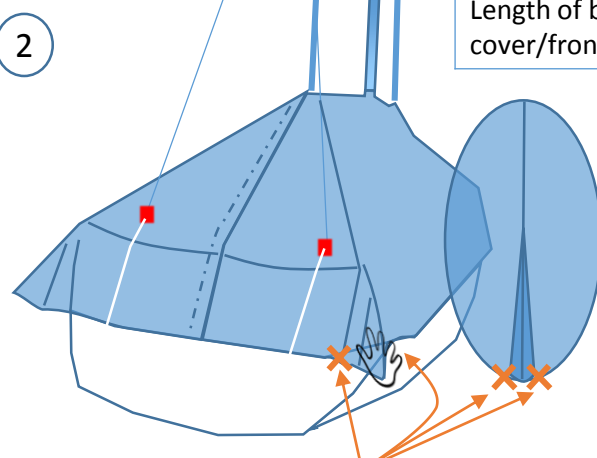

Make sure the marked locations touch each other.

3

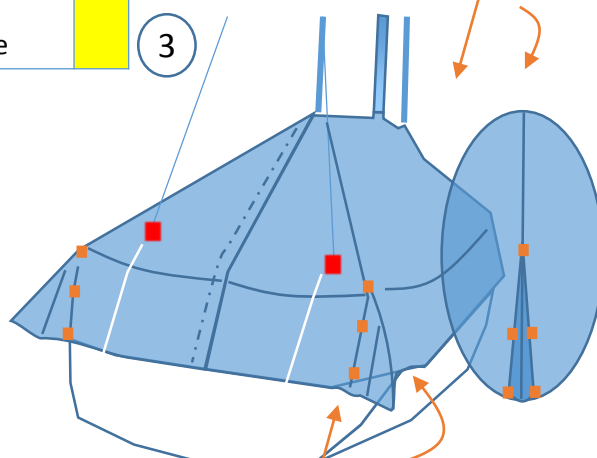

Make sure that both sides are marked.

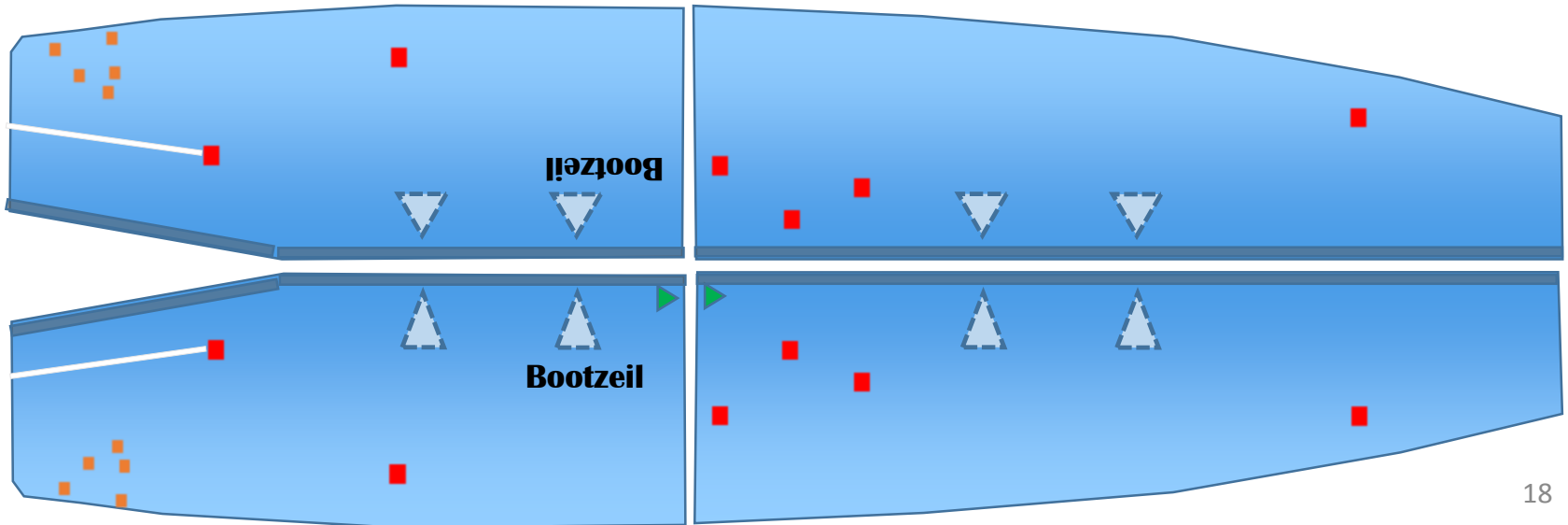

Marking: length of boat cover/front side



Once you've marked the boat cover length correctly on one side, take the boat cover to the shore and fold it lengthwise. Now you can cut both sides at once. This ensures symmetry.

Checklist marking	
Moorings/shrouds	
Corners rear side	
Length of boat cover/front side	



The boat cover should extend about 20 cm past the edge of the boat.

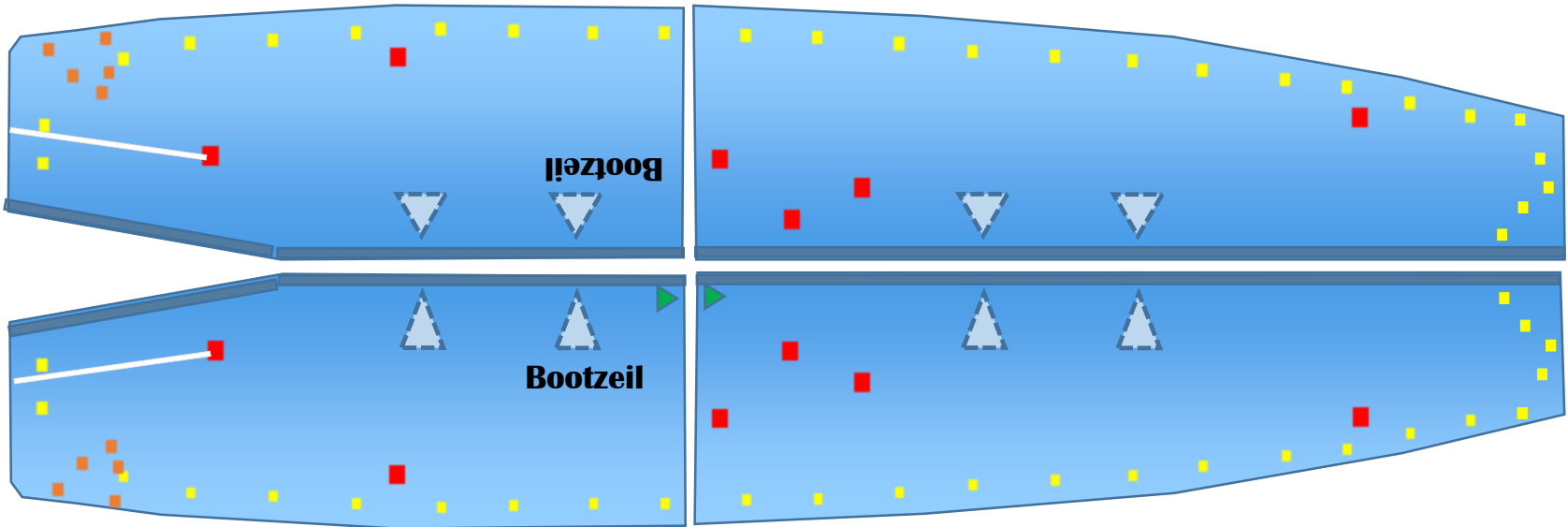
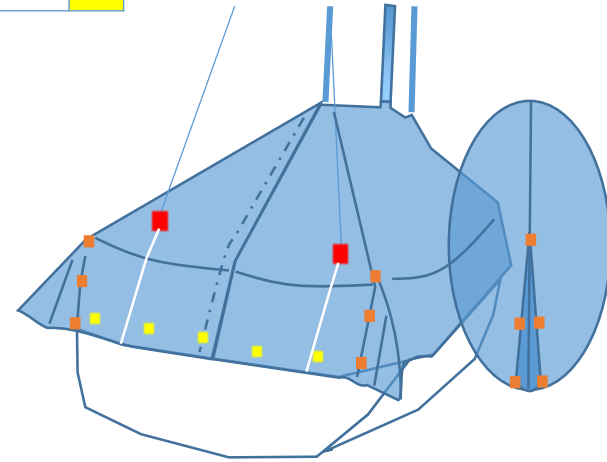
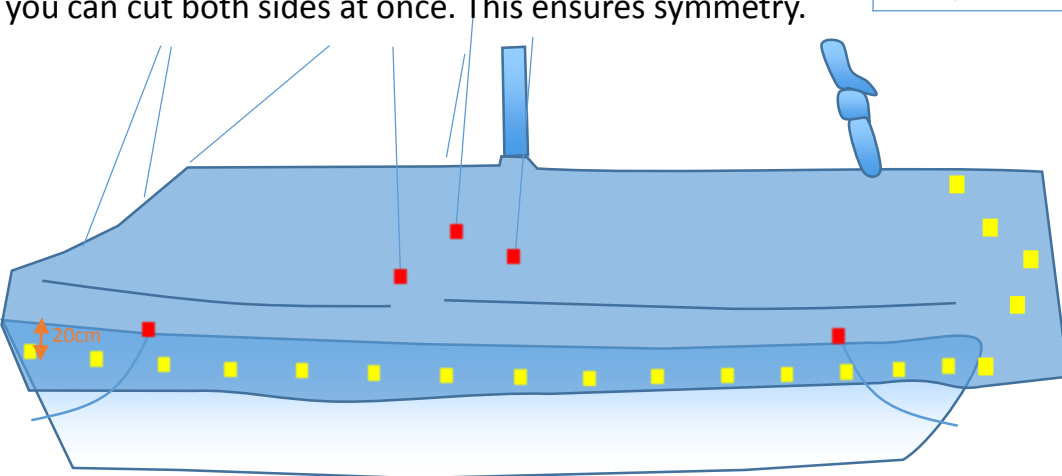

A skirt which is too long can beat against the hull and impede ventilation. We advise you not to make the skirt too long.

Adjusting: cutting the boat cover

Adjustments are made on the shore. You can lay the boat cover on your cover.

i After folding the segments, the boat cover can be symmetrically cut.

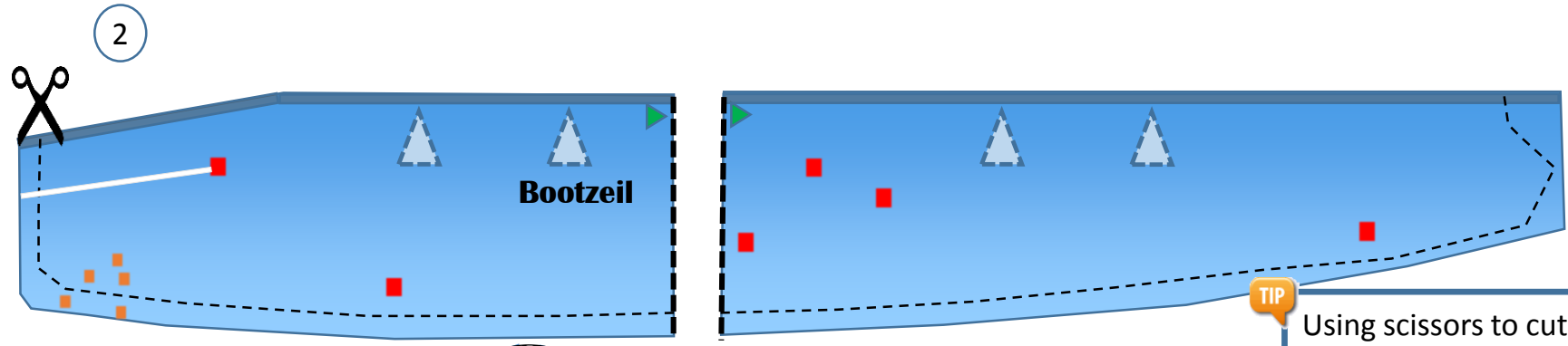
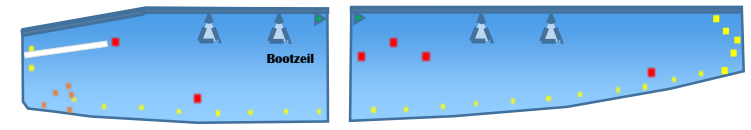
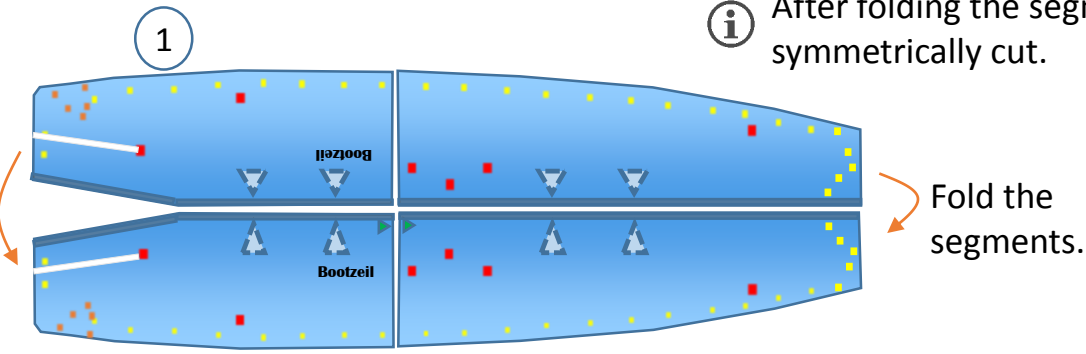

TIP Using scissors to cut?
 Max. 20 mm
 Keep scissors almost closed.

Cut off the excess material.
 Cut around the zipper.
 Put a figure-eight knot in the zipper to prevent the slide from being pulled off.

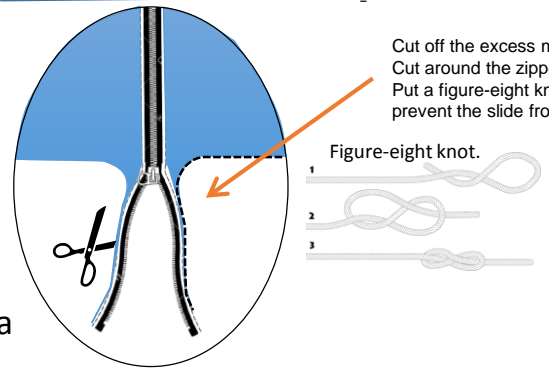

Glue loose stitches with a little bit of griffoen glue (use sparsely).

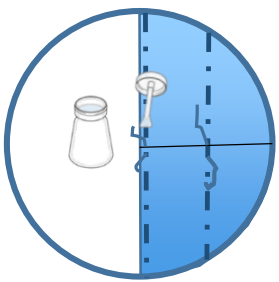

Adjusting: leading the shrouds through

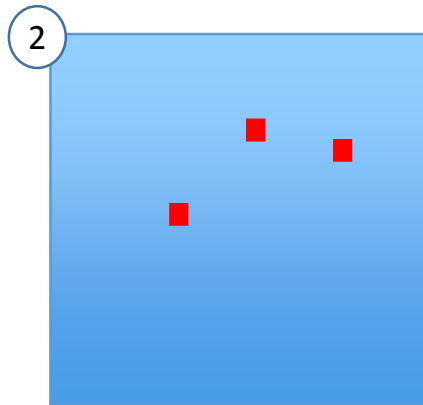
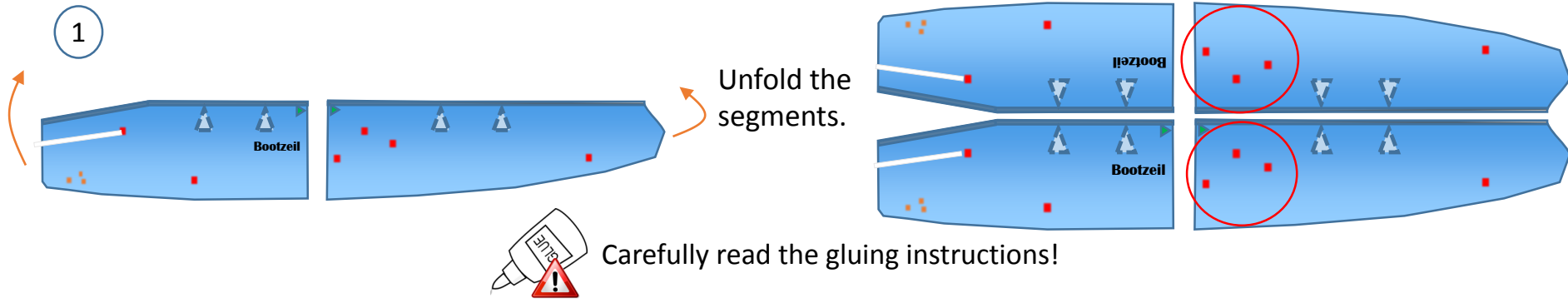

Use the wide Velcro strap.

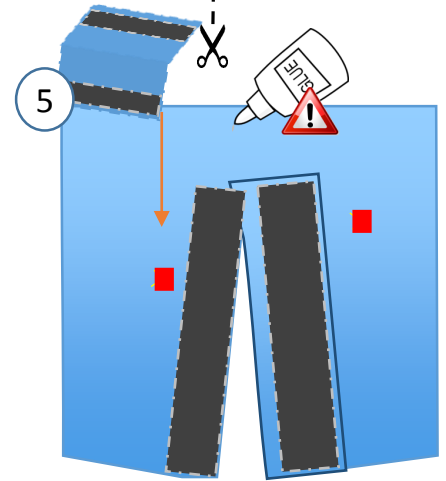
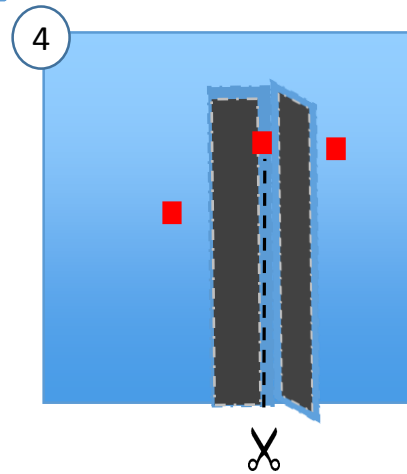
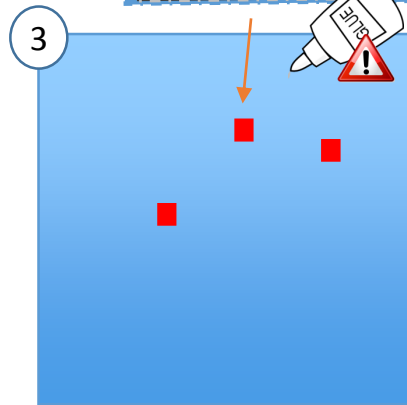

Always stick the side with the cohesive strip on the boat cover.

Adjusting: leading the shrouds through

 Carefully read the gluing instructions!

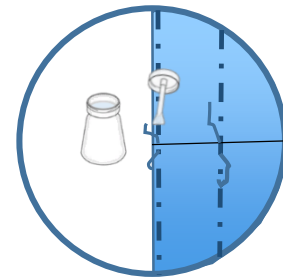
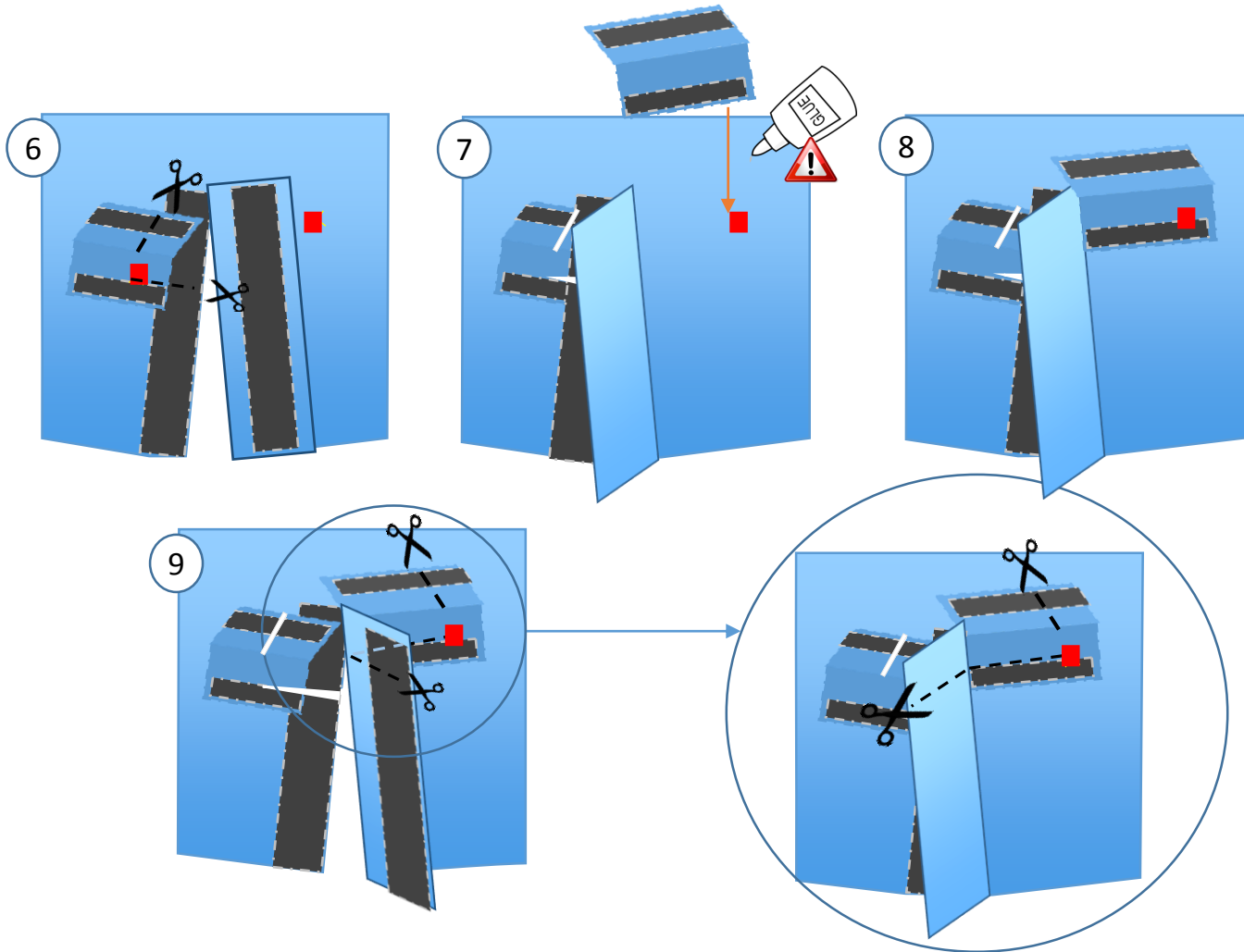

Glue loose stitches with a little bit of griffoen/saba glue (use sparsely). 



Always stick the side with the cohesive strip on the boat cover.

Adjusting: leading the shrouds through

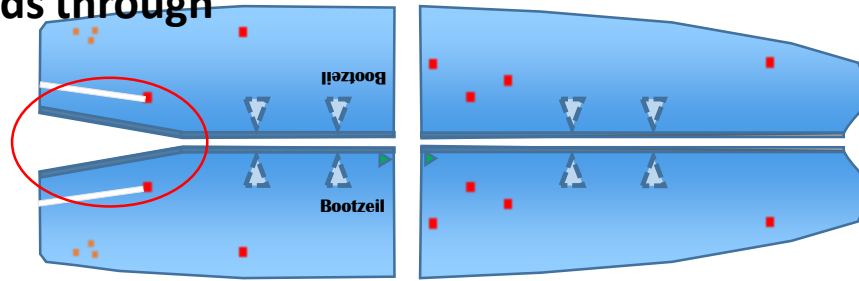

Use the strips of 150 cm.



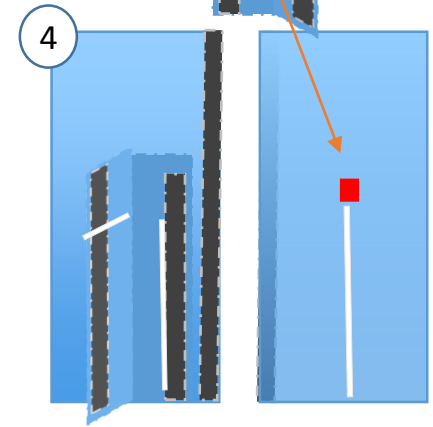
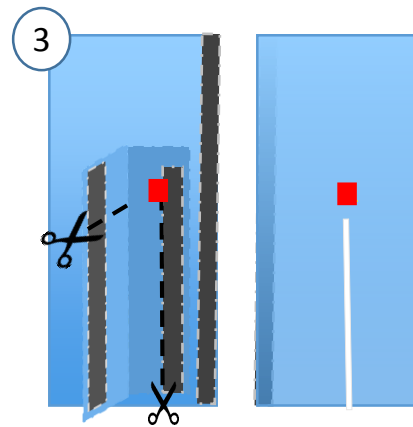
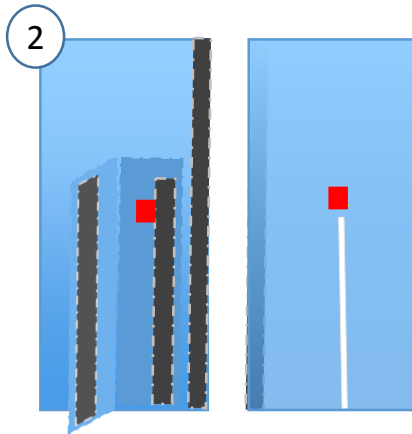
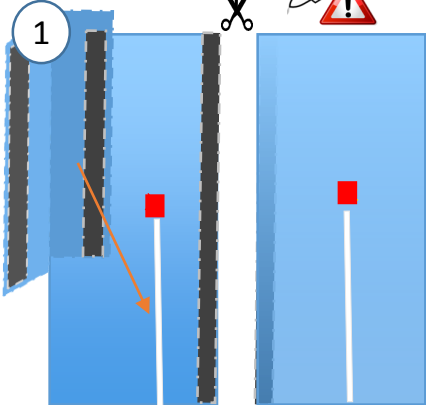

 Cut on the same line as your previous cut.

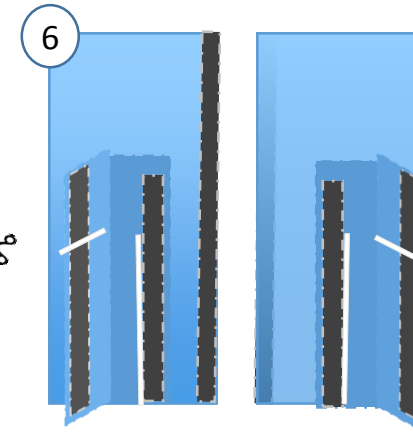
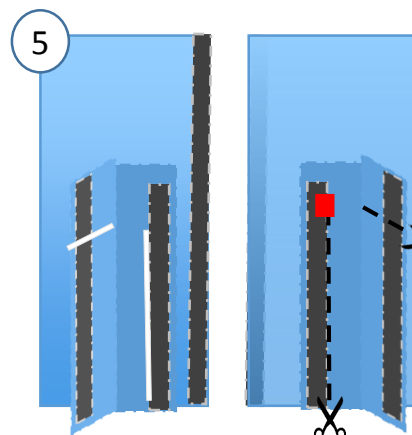

 While fixing the pad, ensure that the sides of the cut you made are held against each other.



 Carefully read the gluing instructions!

 Always only fix the hard part of the Velcro strap to the boat cover.

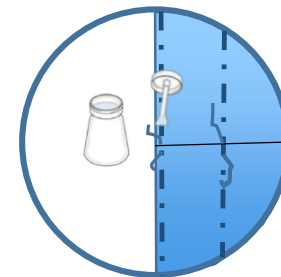

Glue loose stitches with a little bit of griffoen/saba glue (use sparsely).



Adjusting: corners rear side

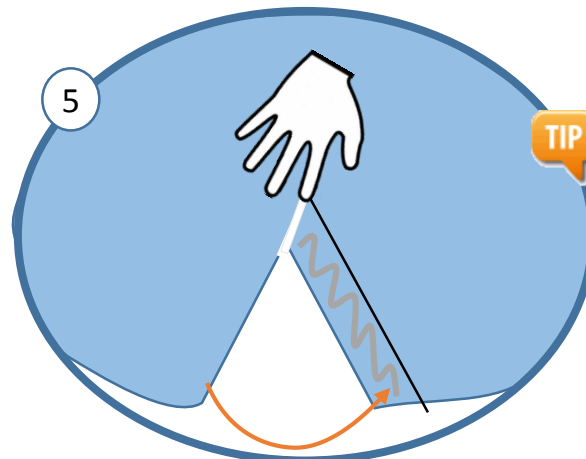
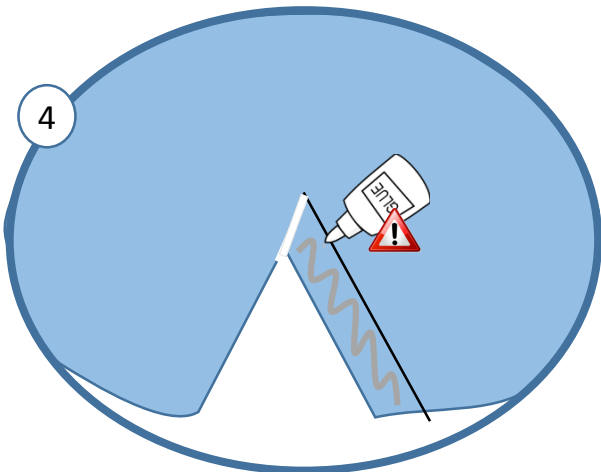
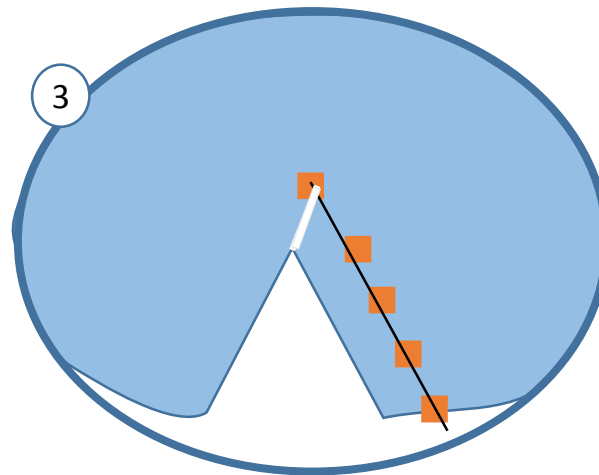
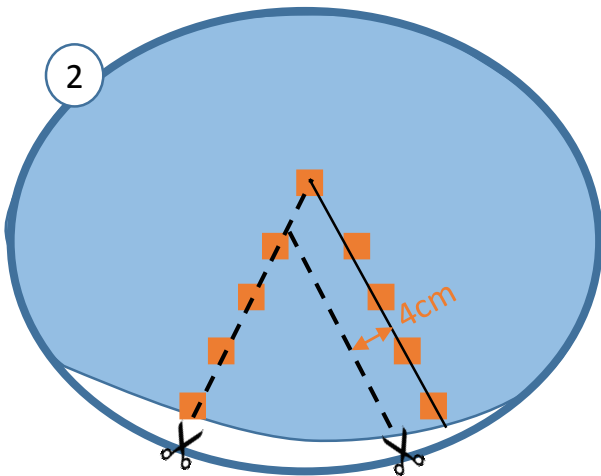
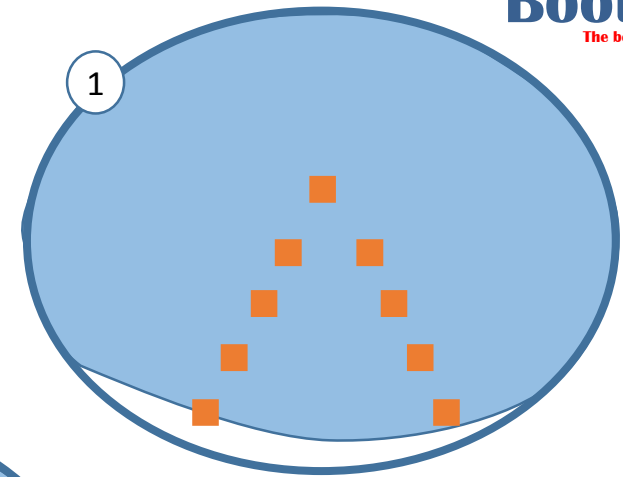
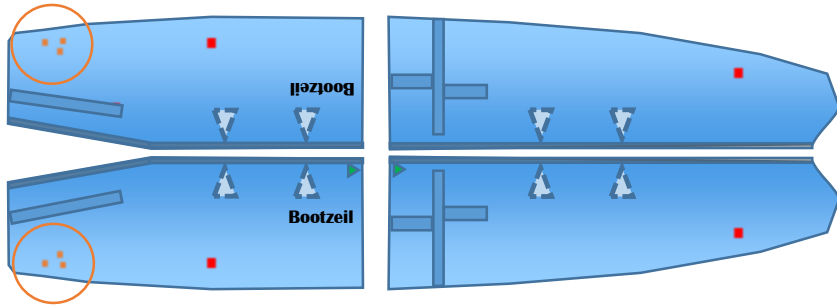

TIP If you hold your finger at the junction of the triangle, it is easier to slide the side over the glued strip.

Adjusting: corners rear side

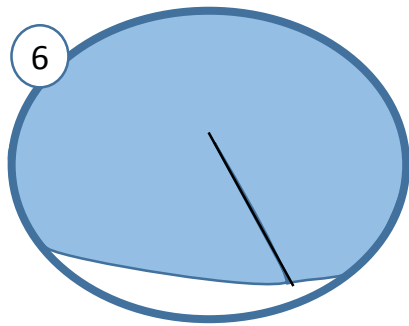

Turning

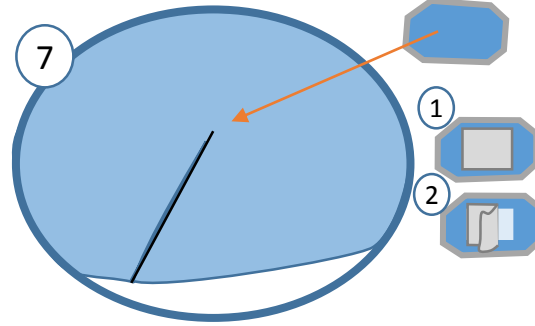

Fix the shape pad type 1 on the inside of the boat cover.
Finish the glue seams with BWF glue (only the sides of the pad).

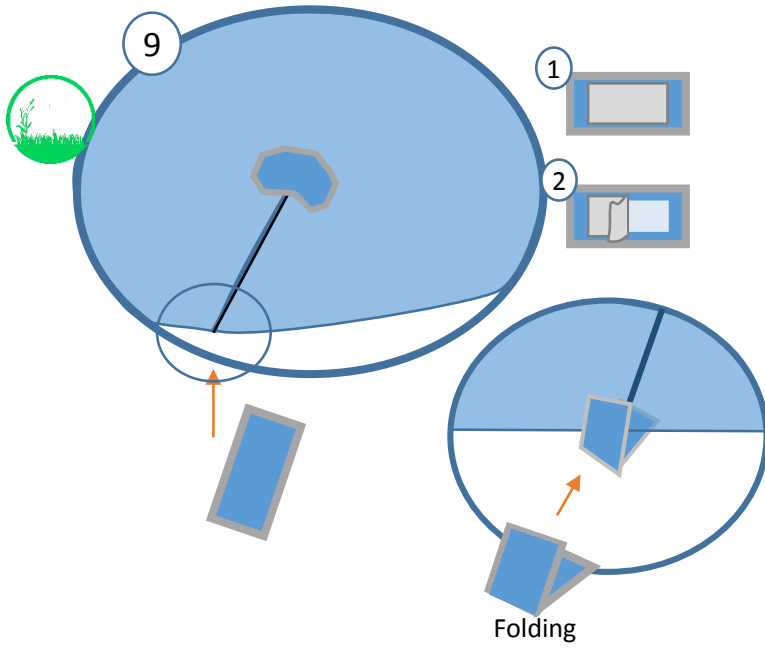
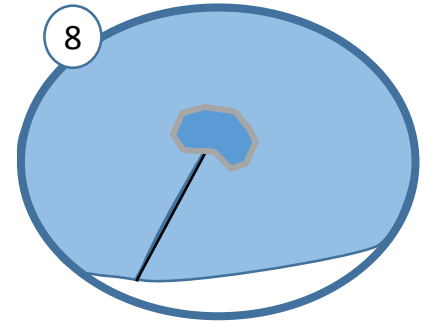

Fix the shape pad type 2 on the boat cover. Finish the glue seams with BWF glue (only the sides).

Adjusting: adding moorings

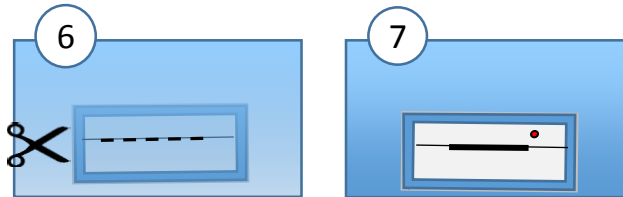
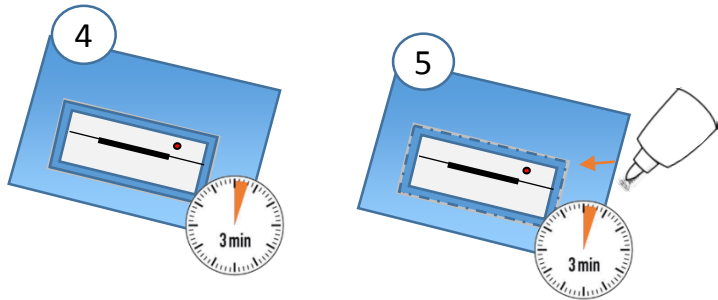
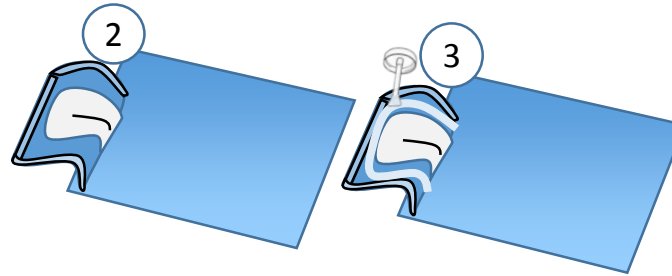
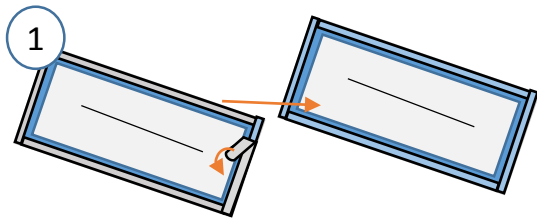
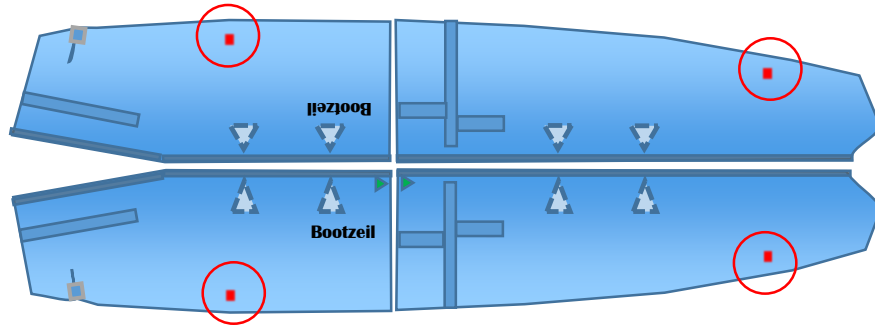

Adjusting: piano seal

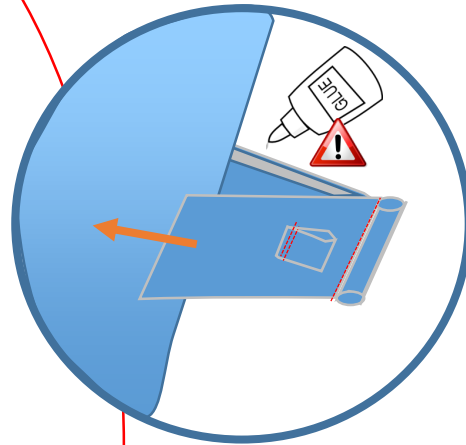
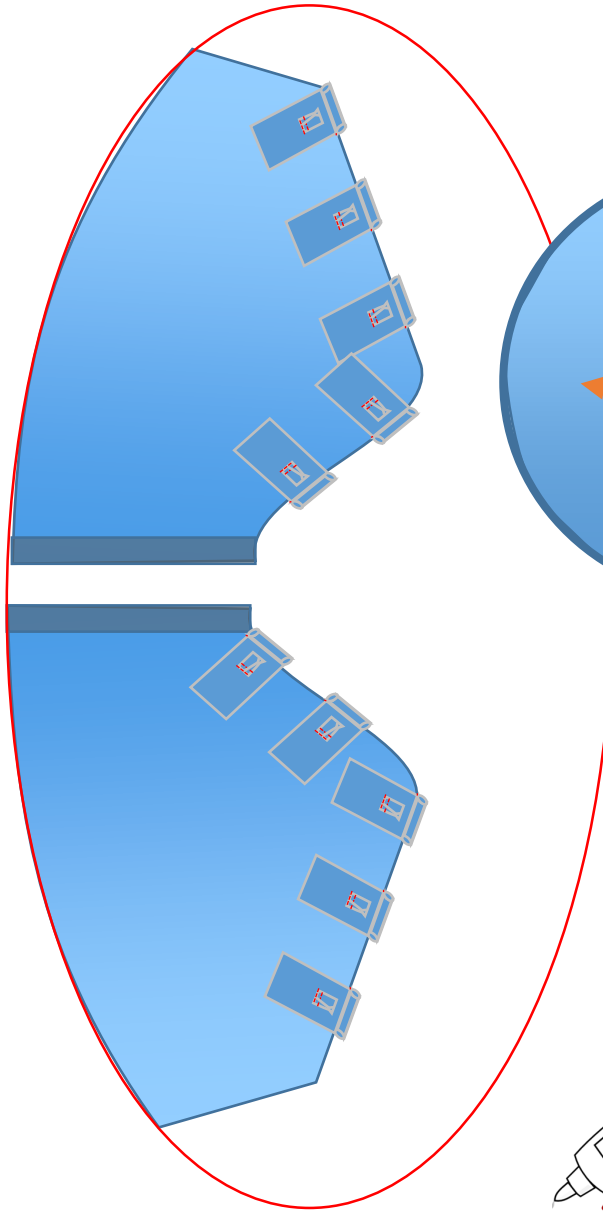
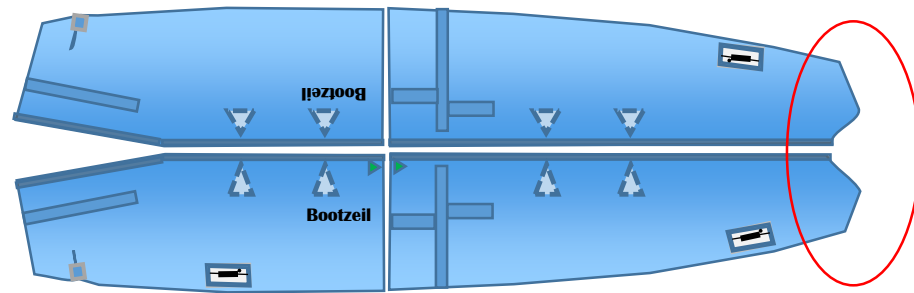

After folding the segments together once more, it should be visible that the hem pads are fixed to the 2 segments one after the other.

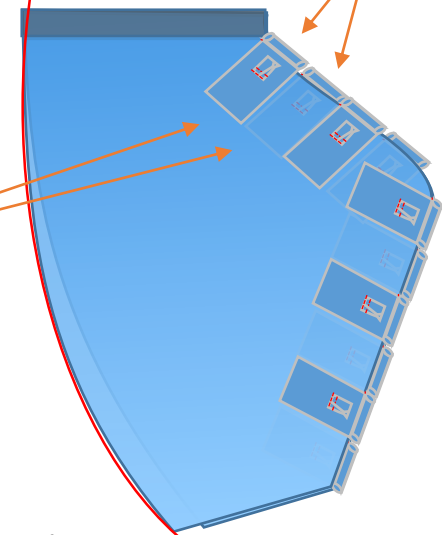

 Position the hem pads one after the other, making sure they are not located opposite one another.



Carefully read the gluing instructions!

Adjusting: in case the boat is kept on the shore (additional)





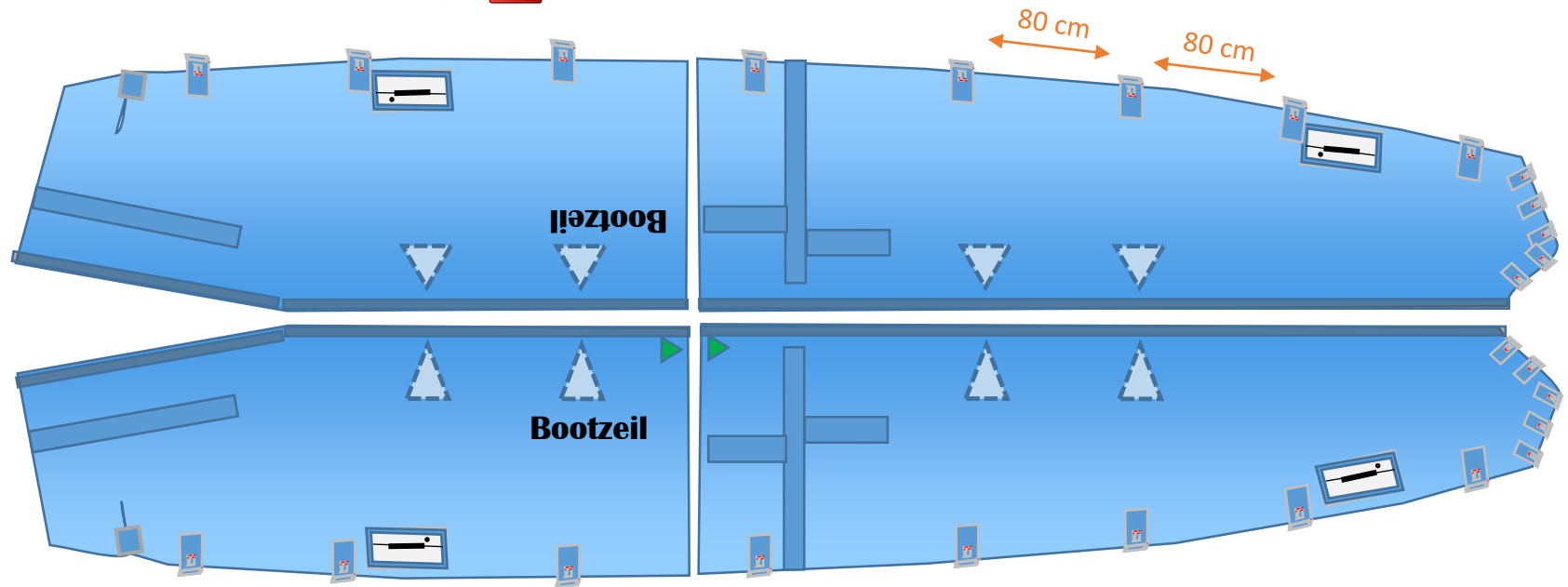

Carefully read the gluing instructions!



- i** The loop/hem pads are placed on the edge of the boat cover, folded around the boat cover and glued in position (hence the two flaps). Attaching the pads to two surfaces of the boat cover enables them to handle more tension. Once they are properly dried, the loops can be used to close the boat cover, lacing it over the bottom of the boat. These pads should be divided over the width of the boat cover, ensuring that the boat cover remains tightly closed and that flapping is prevented.

Adjusting: final result

Checklist adjusting	
Length of boat cover/front side	
Moorings/shrouds	
Corners rear side	
Piano seal	
(Boat on the shore)	

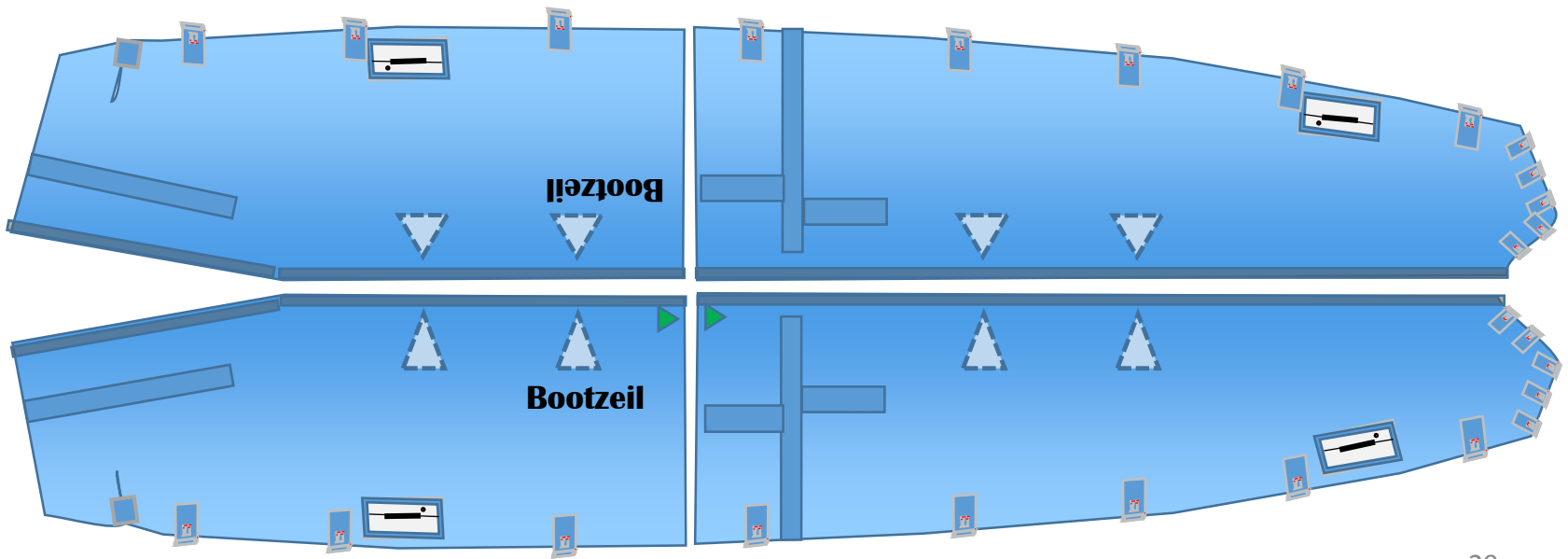
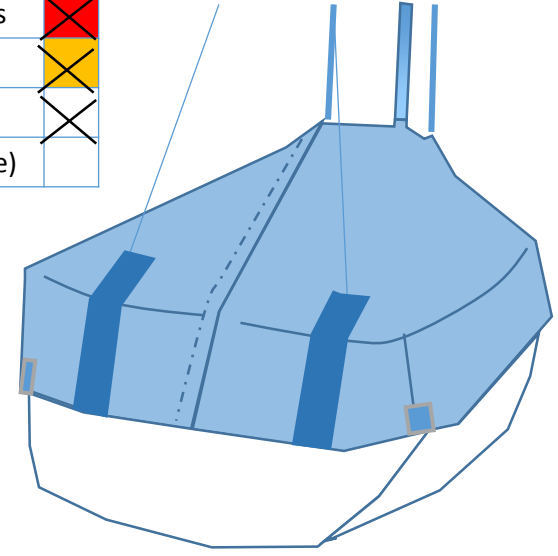
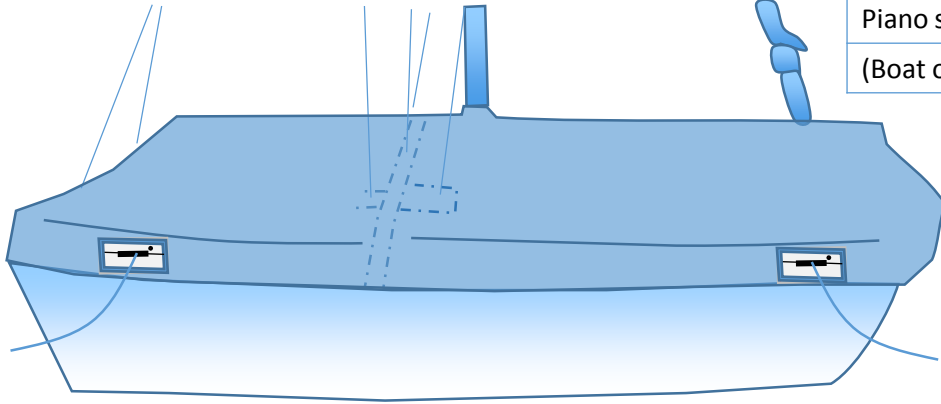

Placing: placing the boat cover and leading the moorings through

Placing takes place on the boat.

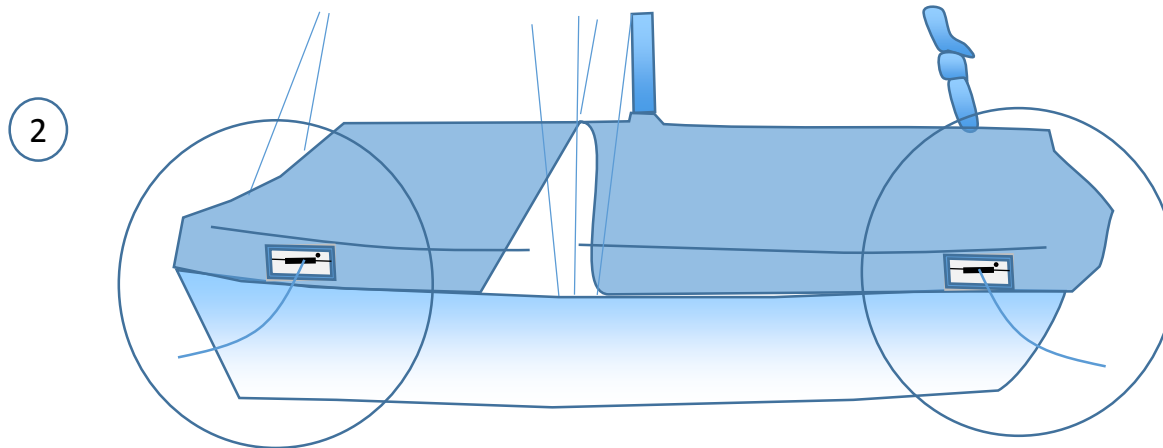
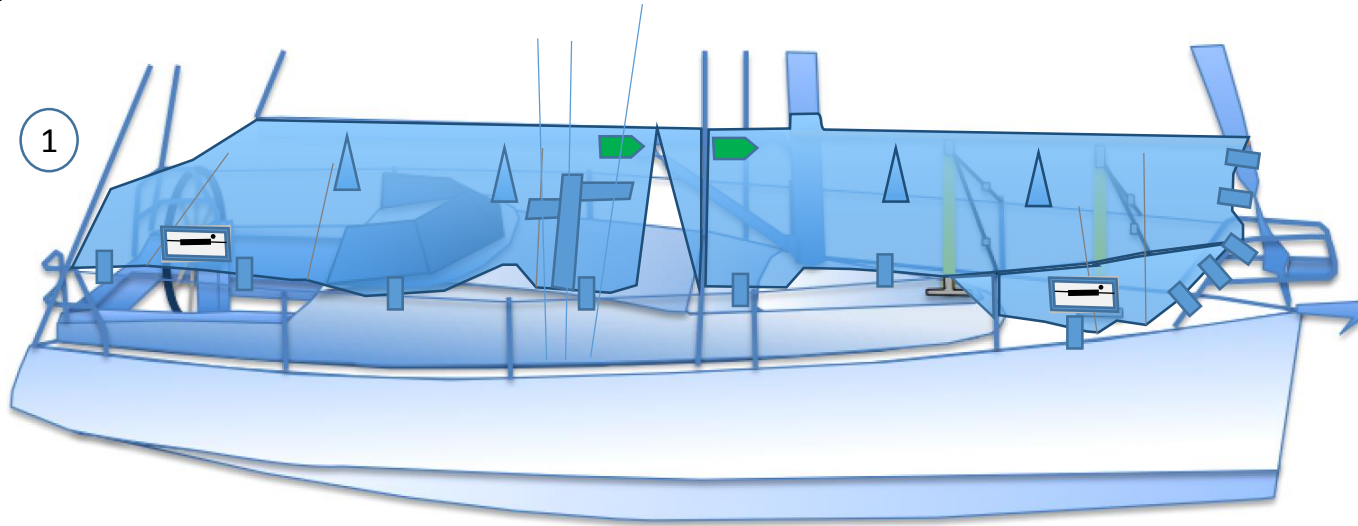

Lead the mooring through the mooring slit.

Placing: leading the shrouds through

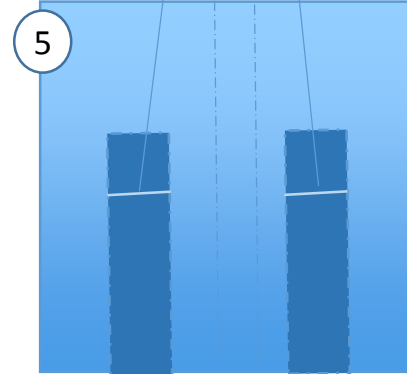
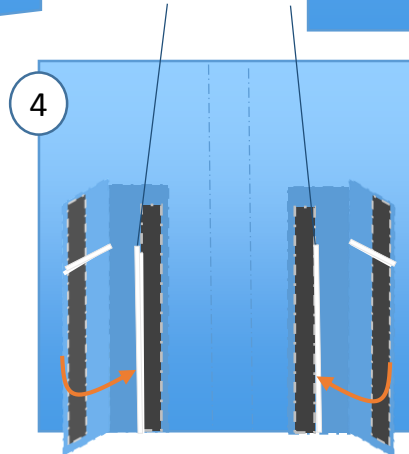
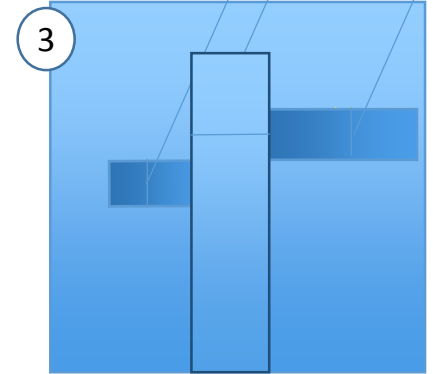
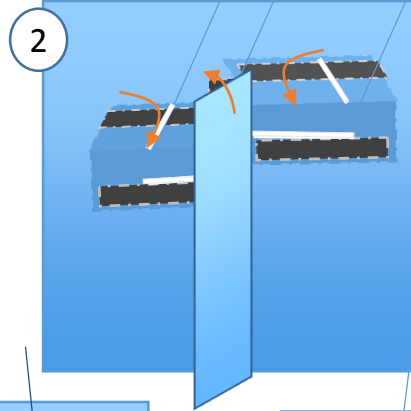
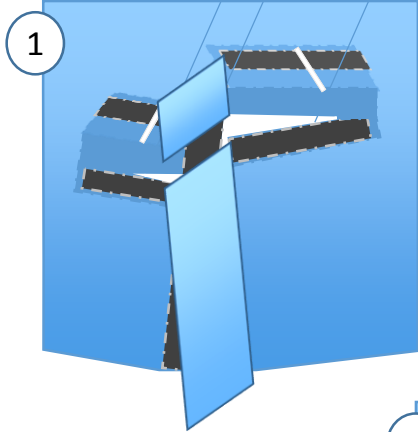
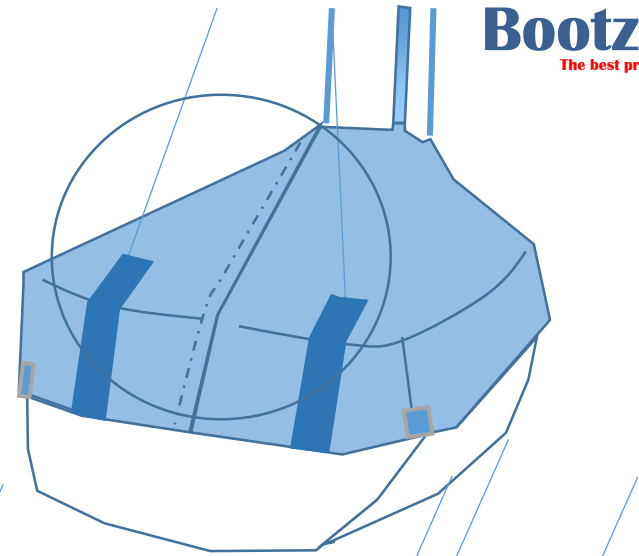
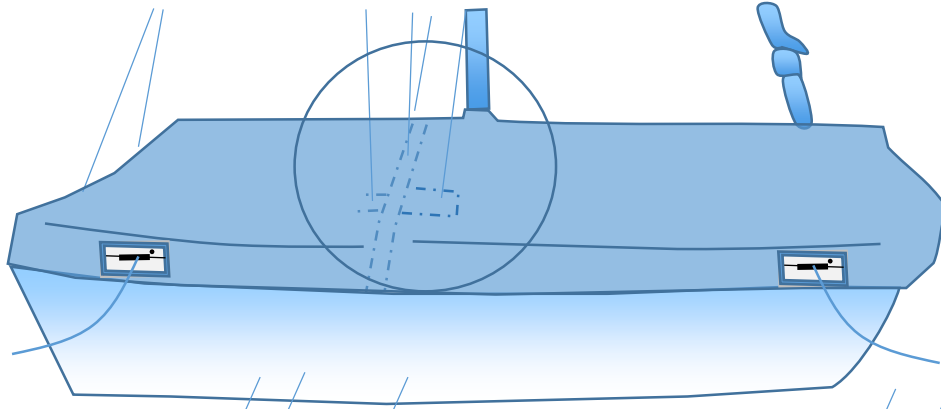

Placing: piano seal

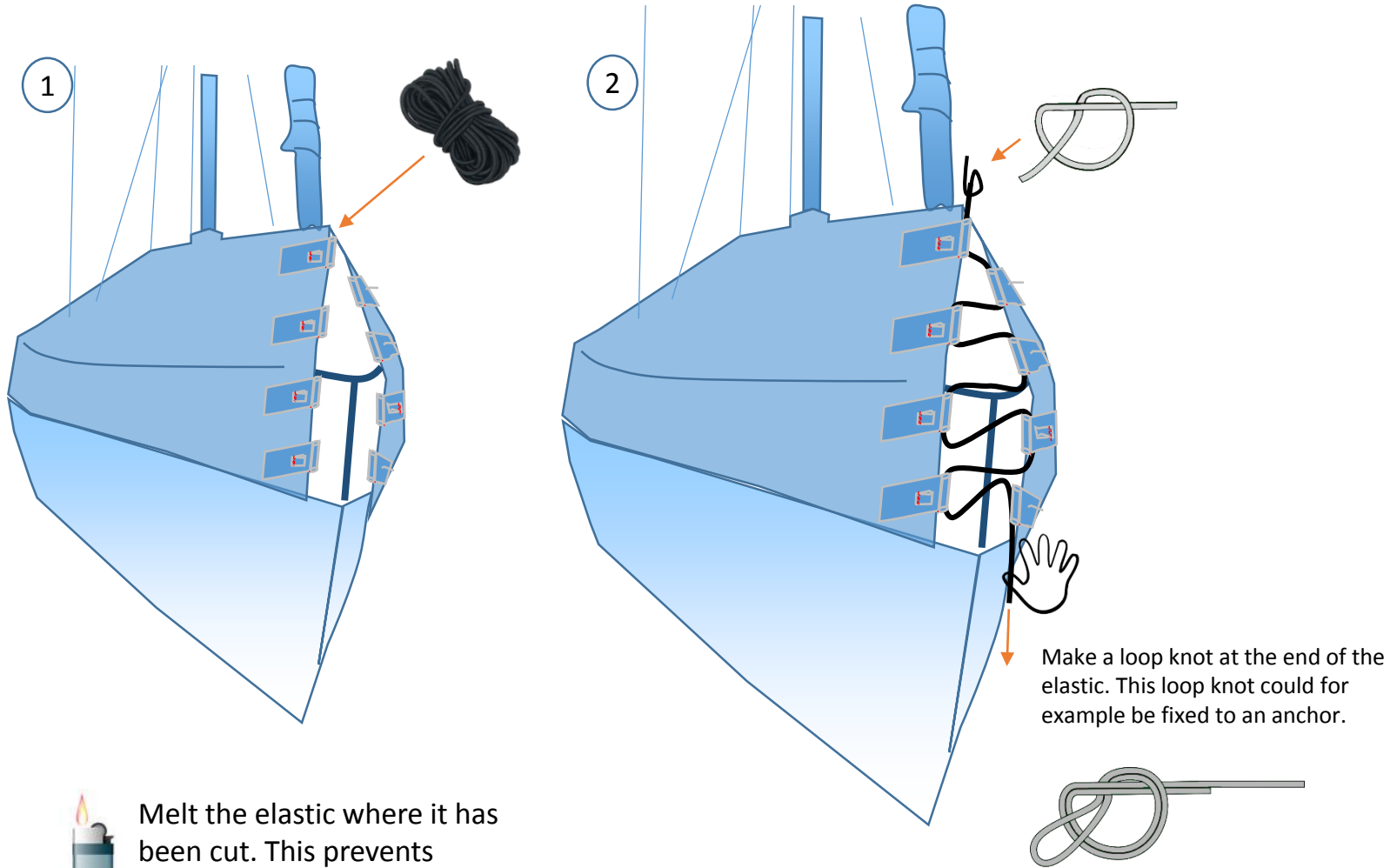

Melt the elastic where it has been cut. This prevents fraying.



Close the piano seal by directing an elastic through the hems. An advantage of this kind of seal is ample ventilation.

Placing: fixing the shock-absorbing straps

- i** The shock-absorbing straps have 2 hooks, constituting 2 anchorages.

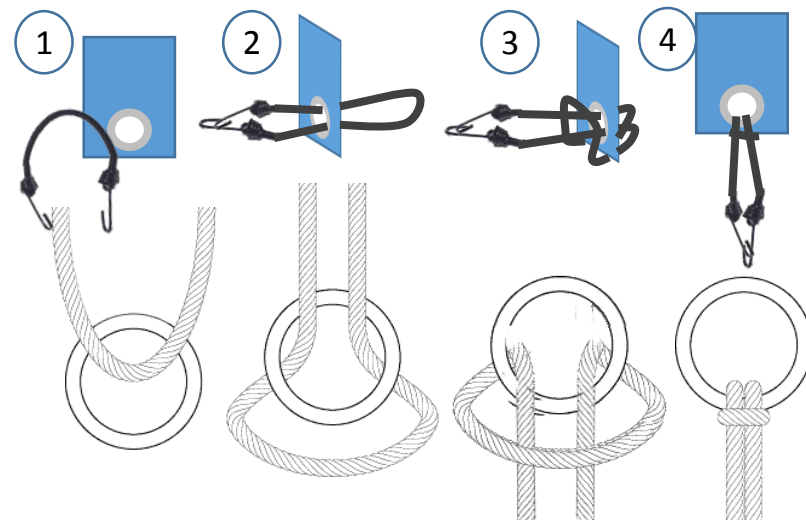
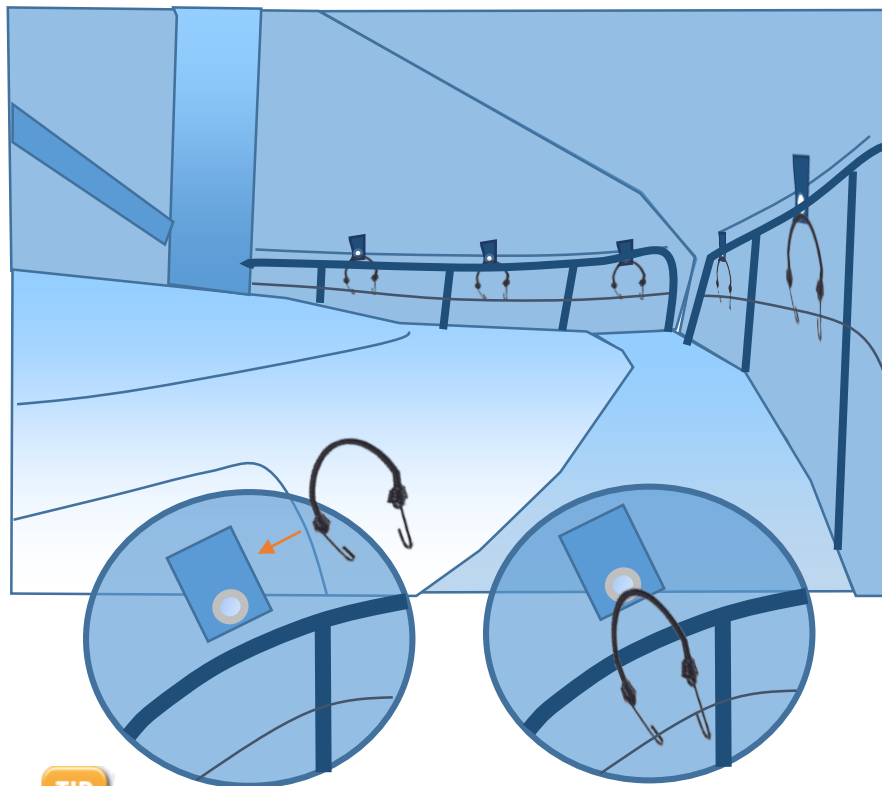

Attach the boat cover to the boat with shock-absorbing straps. Use the loops which are most suited for your boat.

TIP

If you prefer, it is possible to place loops elsewhere in the boat cover. Using the gluing instructions, you can easily place an inside loop pad at the preferred position.

Placing: strengthening the boat cover

- i** Where the boat cover rests on relatively sharp corners and edges, it is advisable to use strengthening pads to strengthen it.
(Do so on the inside of the boat cover.)

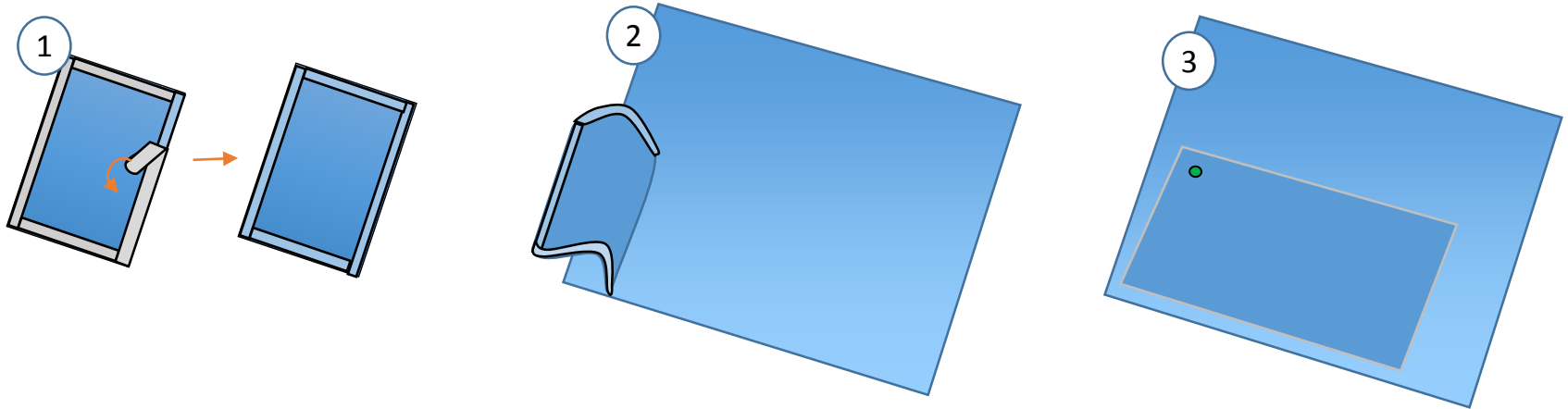

Place the strengthening pads on the inside of the boat cover. There is no need for glue, the tape is sufficiently strong.

Placing: wind protection pads

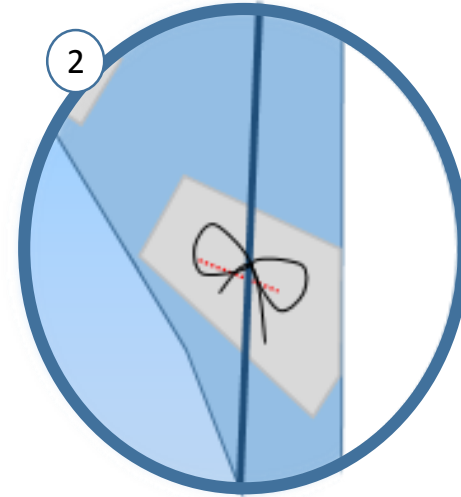
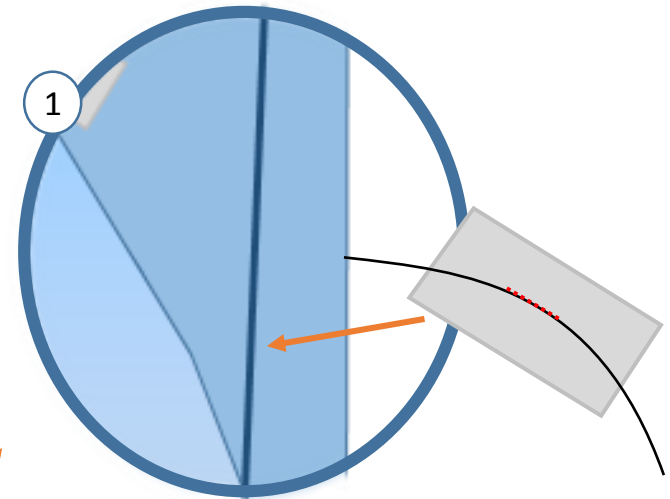
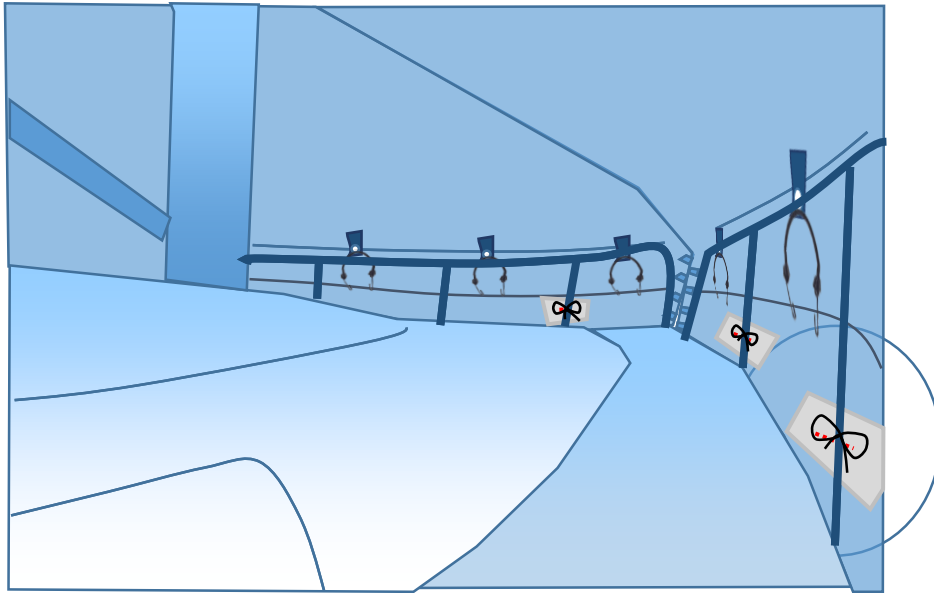

Place the wind protection pads on the inside of the boat cover. There is no need for glue, the tape is sufficiently strong.

i The wind protection pads ensure that the sides of the boat cover remain properly attached around the boat.

Fixing the boat cover after the first installation

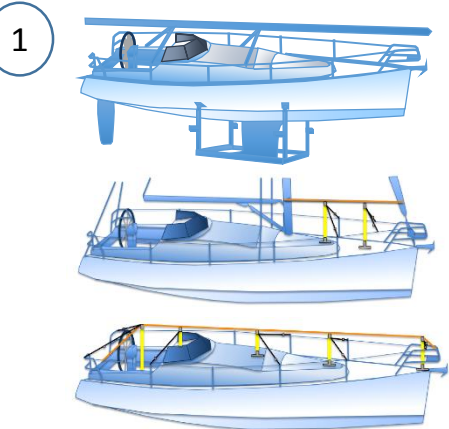

Placing the frame

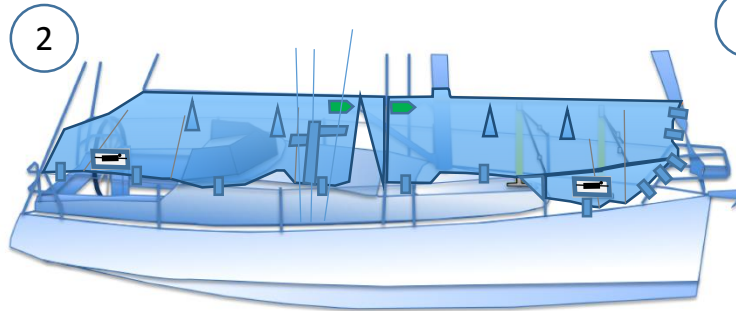

Placing the boat cover and leading the shrouds and moorings through

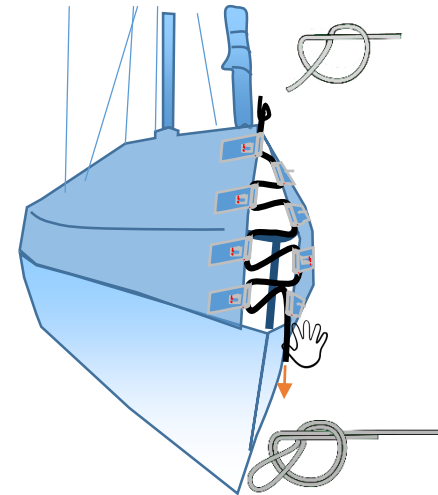

Piano seal

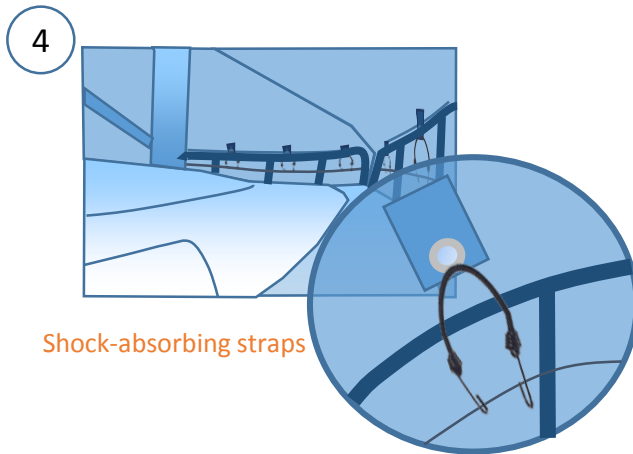

Shock-absorbing straps

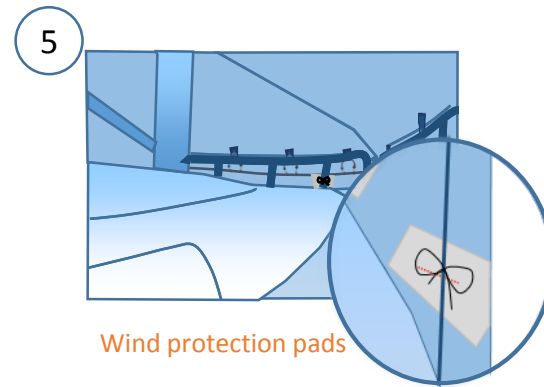

Wind protection pads

FAQ

General

The measurements of the Pampus boat cover are such that it fits approximately. Therefore there will always be some wrinkles. Bootzeil has a service workshop, where we can make adjustments to your boat cover. Upon request we can also place additional zippers.

The boat cover is too narrow/doesn't fit

Give us a call. Thanks to our experience we can give you hints on how to make the boat cover fit. If necessary, we will request you to send us a few pictures.

The boat cover is too short

Fix the boat cover on the rear side, and pull it from the front side as tightly as possible. In case the boat cover is more than 10 cm too short, give us a call and send us a few pictures. We will be glad to assist. If necessary, we will pay you a visit.

The boat cover doesn't cover the bumper

It may seem as if the boat cover doesn't cover the bumper. Often the boat cover fits better once the loops have been fixed to the railing. In case the boat cover is still too narrow, it can often be solved with a small adjustment to the frame. In case the boat cover is 5 cm too narrow, you can shorten the frame 7.5 cm.

I would like someone to install my boat cover

Bootzeil cooperates with a group of experienced installers. They work throughout the country, and often even during weekends. On average an installation costs €550, depending on the number of working hours and the travel time. The installers can also measure adjustments and correctly and carefully forward them to our workshop. Call 023 – 521 96 92 to make an appointment immediately.

I have found a few stitching errors

Bootzeil hires trained experts who produce the boat covers by hand and deliver almost impeccable work. Handmade, however, means that mistakes may occur. During the spring service, we gladly repair affecting errors (for free).

The stitches seem to be wet

The first few months the stitches may absorb moist. This occurs because they were produced and processed in an industrial environment. Moulding causes the pores to block, which makes the stitches watertight in due course. Waterstop spray can speed this process up.

**In case your question has not been answered, give us a call. We will gladly assist you.
023 - 521 96 92**



Bootzeil also makes bespoke customized covers for your garden furniture. Marina quality.

www.bootzeil.nl